

USER MANUAL

ETH-E
ETH-E/HW

ETERNA HOSPITAL



EN

**Automatic pedestrian
sliding door
hermetically sealed
for hospital environments**



TRANSLATION OF THE ORIGINAL
INSTRUCTIONS



RECOMMENDATIONS

THIS INSTRUCTION MANUAL IS INTENDED FOR THE FINAL USER OF A LABEL AUTOMATIC SLIDING DOOR SYSTEM; IT IS UNDERSTOOD THAT INSTALLATION AND TESTING MUST HAVE BEEN CARRIED OUT BY SPECIALISED PERSONNEL.

GENERAL SAFETY WARNINGS



CAREFULLY READ THIS MANUAL BEFORE COMMISSIONING THE AUTOMATIC DOOR.

PROVISIONS

The automation has been designed to be used exclusively with pedestrian automatic sliding doors.

The manufacturer shall not be liable for incorrect product usage, as well as for any damages arising from changes to the system made without its prior consent.

When operating the system, accident prevention regulations must be observed.

REMARKS

Always respect the usage and maintenance conditions provided for by LABEL.

The equipment can be used by children of at least 8 years of age and by people with reduced physical, sensory or mental skills, or by inexperienced people, provided they are supervised, or after the same have received instructions relating to the safe use of the equipment and to the understanding of the relevant hazards.

Children should not play with the equipment.

Cleaning and maintenance intended to be performed by the user must not be carried out by children without supervision.

Maintenance and repair operations must only be performed by qualified and properly trained personnel.

PROPER BEHAVIOUR

Only use the automatic door if it is in perfect technical conditions.

In case of failure or malfunction that might affect safety, immediately contact the service centre.

Inappropriate use of the system may cause serious injuries and damage.



AUTOMATIC SLIDING DOOR

**HOSPITAL
models:
ETH-E
ETH-E/HW**

CONTENTS:

RECOMMENDATIONS	2
GENERAL SAFETY WARNINGS	2
1) INDICATIVE DESCRIPTION OF THE SYSTEM	4
2) TECHNICAL SPECIFICATIONS OF THE AUTOMATION ETH-E	4
3) AUTOMATIC DOOR OPERATION	5
3.1) NORMAL DOOR OPERATION	5
3.2) DOOR OPERATION IN NIGHT LOCK MODE	5
4) PROGRAM SELECTORS	5
4.1) MECHANICAL KEY SELECTOR EV-MSEL	5
4.2) DIGITAL PROGRAM SELECTOR HB-DSEL	6
4.2.1) GENERAL PROGRAMMING MENU	8
4.2.2) PASSWORD	9
4.2.3) LANGUAGE	11
4.2.4) SELECTOR OPTIONS	12
5) OPERATION IN CASE OF POWER SUPPLY FAILURE	13
6) NOTIFICATION OF ERRORS AND OPERATIONAL ISSUES	14
7) MAINTENANCE	15
8) DISPOSAL	15

1) INDICATIVE DESCRIPTION OF THE SYSTEM

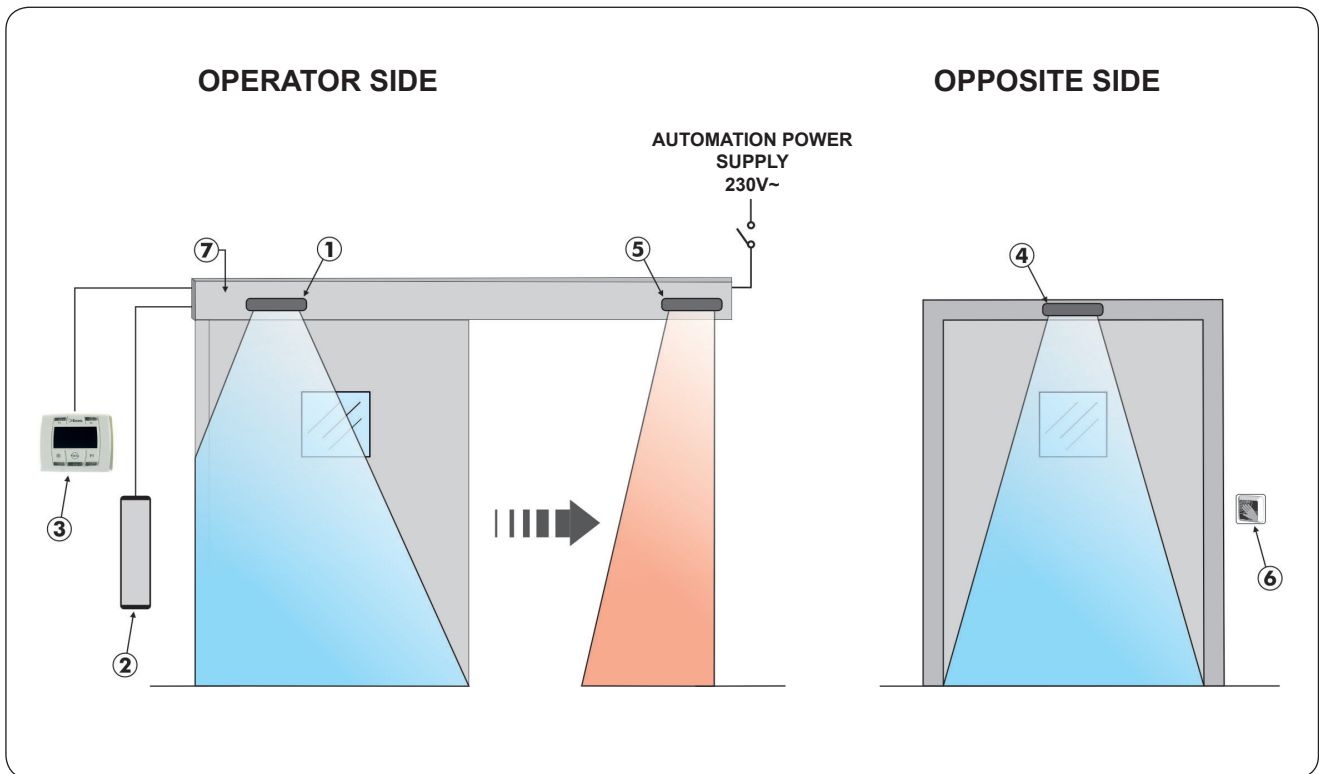

① Closing safety sensor

② Opening button

③ Digital programmer

④ Closing safety sensor

⑤ Opening safety sensor

⑥ Touch-sensitive detector

⑦ Automation ETH-E

2) TECHNICAL SPECIFICATIONS OF THE AUTOMATION ETH-E

AUTOMATION MODEL	ETH-E	ETH-E/HW
MAX LEAF WEIGHT	150 Kg	250 Kg
POWER SUPPLY	230V~ 50Hz +/- 10%, 115V~ 60Hz +/- 10%	
MAX. POWER	100 W	
FREQUENCY OF USE	continuous	
PAUSE TIME	Max. 30 sec.	
OPERATING TEMPERATURE	-15°C +50°C	
PROTECTION CLASS	IP22	
POWER SUPPLY OF EXTERNAL ACCESSORIES	24 Vdc	
DIMENSIONS OF THE AUTOMATION ETH-E (H x D)	135 x180 mm	

3) AUTOMATIC DOOR OPERATION

WARNING!!

Always contact the service technician before putting into service the door, to learn how the automation works.

Switch on the power supply by means of the system switch.

The automation electronic control unit beeps shortly to indicate that the automatic door is powered.

The first opening command starts a calibration cycle during which the door opening speed is very low until the end of the motion, to find the stop point; after the delay time has elapsed, the door closes back at normal speed.

3.1) NORMAL DOOR OPERATION

- When the radars are activated, the door opens and stays open until the sensors detect the presence, then once the pause delay has elapsed the door closes back.
- When the door opening button is pressed, the door opens and stays open until the command remains active, then once the pause delay has elapsed it closes back.
- If the closing safety sensor detects a presence, the door immediately reopens, and stays open as long as the sensor remains engaged.
- If the opening safety sensor detects a presence, the door slows down and proceeds very slowly until the opening motion is completed.
- If during the opening motion the door collides against an obstacle, it stops and closes back. When it opens again, later, it slows down near the point where it had met the obstacle, to avoid further impact.
- If, during the closing motion, the door collides against an obstacle, it stops and opens back. When it closes again, later, it slows down near the point where it had met the obstacle, to avoid further impact.

3.2) DOOR OPERATION IN NIGHT LOCK MODE

- The door cannot be opened by means of the external and internal radars.
- The door can only be opened by pressing the OPEN button, or using the Spyco radio-control, if any.
- The safety functions (sensors and behaviour in case of obstruction) are active and operate as described in par. 3.1. related to normal operation.

4) PROGRAM SELECTORS

The program selector allows the user to select the operating mode of the door.

Depending on your preferences, it is possible to use the mechanical key selector EV-MSEL or the digital selector HB-DSEL.





Each program selector is fully described below.

4.1) MECHANICAL KEY SELECTOR EV-MSEL

OPERATING MODE

Insert and turn the key of the selector EV-MSEL to select the desired program.



	Open door program The door remains motionless in the position of complete opening.
	Reduced opening during winter To open the door partially
	Automatic bidirectional program The door automatically opens after an opening command.
	Automatic unidirectional exit only program To disable entry detection on external Radar input.
	Night lock program The door can only be opened through the OPEN input or using the SPYCO remote control, if any.

The key can be taken out of the selector when in any position in order to prevent undesired changes to the work program.

4.2) DIGITAL PROGRAM SELECTOR HB-DSEL



Pressing briefly the button , select the automatic door operating mode. Whenever the button is pressed, you switch from a work program to the next.

The operating programs which can be selected using the button  are described below.



Automatic bidirectional program

The door automatically opens after an opening command.



Automatic unidirectional exit only program

To disable entry detection on external Radar input.



Automatic unidirectional entry only program

To disable exit detection on internal Radar input.



Open door program

The door remains motionless in the position of complete opening.



Night lock program

The door can only be opened through the OPEN input or using the remote control, if any.



Manual free door

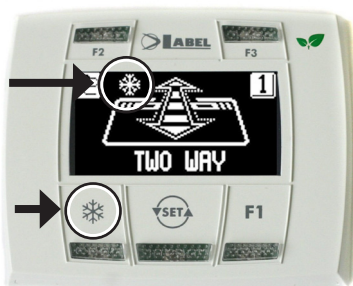

Automatic operation is disabled and the door can be opened manually.

Operation of other buttons located on the panel of the program selector HB-DSEL



REDUCED OPENING DURING WINTER

To reduce the passage opening.

To activate reduced opening during winter, press once button .
The symbol  on the display indicates that the function is on.

To disable reduced opening during winter, press once more button .

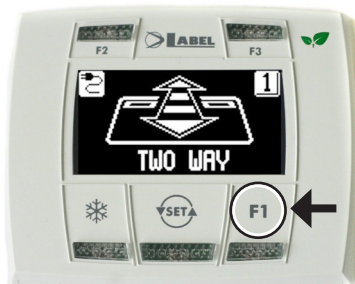

F1

Door opening command

Pressing the F1 button will open the door.

The button F1 may open the door even when the "NIGHT LOCK" work program is selected, if the automation electronic control unit is set accordingly.



F3

It is only used if the digital selector HB-DSEL manages two automatic doors

The HB-DSEL digital programmer can independently manage the operation of two ETH-E sliding automatic doors.



Pressing button F3, you select the door on which the work program is set;

The number 1 appears on the display when door 1 is selected; the number 2 appears if door 2 is selected.

4.2.1) GENERAL PROGRAMMING MENU

The user can enter the general programming menu when he wishes to select the desired language for the texts that appear on the display, or when he wishes to enable a password to prevent any unauthorised access to the digital selector HB-DSEL.

DIAGRAM 1

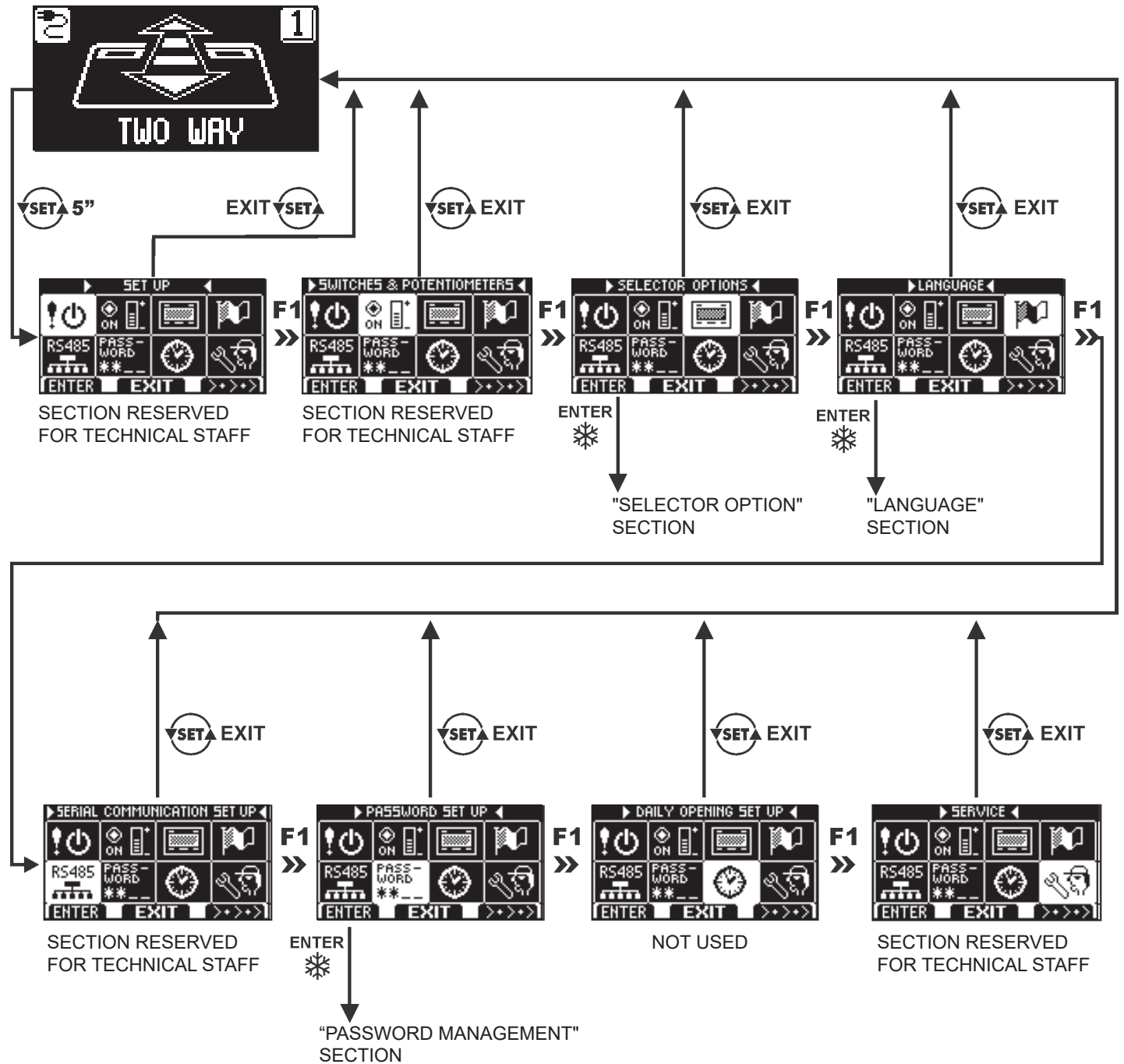

The paragraphs below explain the procedure to be followed to manage the user password and to select the language.

4.2.2) PASSWORD

To prevent the door work program from being modified, it is possible to set a password that must be entered every time the selector HB-DSEL is used.

To enable the password, perform the operations listed below:

1. Press the SET button for 5 seconds to access the general programming menu (see Diagram 1 at para. 4.2.1)
2. Press the button F1 five times to go to the Password Management sub-menu.
3. Press the Enter button  to access the section "Password management".

PASSWORD MANAGEMENT



This section displays the two passwords available to the final user, the primary password and the service password.

The technical password is only reserved for the technical staff in charge of installation and maintenance operations.

PRIMARY PASSWORD (for the system owner-user)

It is a 5-character password used by the user to prevent unauthorized persons from having access to the selector HB-DSEL and change the work program.

Using a primary password is optional and must be enabled by the system owner.

The default technical password is "A-A-A-A-A".

WARNING!

When enabling the password, be very careful not to forget the access combination.

SERVICE PASSWORD (for user)

It is a 5-character password that the system owner may provide to persons authorized to use the selector HB-DSEL.

With the service password, it is only possible to change the work program of the automatic door.

The default service password is "A-A-A-A-A".

To change the service password, it is necessary to log in using the primary password.

Use the button  to move the selection arrow downwards, use the F2 button to move the arrow upwards.

HOW TO CHANGE THE PRIMARY PASSWORD

Select "PRIMARY PASSWORD"

Press OK (F1).



- Type the default primary password "A-A-A-A-A" by pressing 5 times the button A. (If the primary password is not the default password, since it had already been changed before, enter the currently-used primary password).



- Enter the new primary password, selecting a combination of 5 characters from the letters A-B-C-D.



- You are prompted to repeat the new password, so enter again the previous combination.



- If the password entered is correct, the message "PASSWORD OK" is displayed for one second, then the system returns to the PASSWORD MANAGEMENT section. Press the EXIT  button to return to the general programming menu
- If the password you entered does not match the previous one, the display shows PASSWORD ERROR, the system returns to the section PASSWORD MANAGEMENT and it is necessary to perform again the procedure.

HOW TO CHANGE THE SERVICE PASSWORD

- Select "SERVICE PASSWORD"
- Press OK (F1).



- Enter the primary password



- Enter the new service password, selecting a combination of 5 characters from the letters A-B-C-D.



- You are prompted to repeat the new password, so enter again the previous combination.

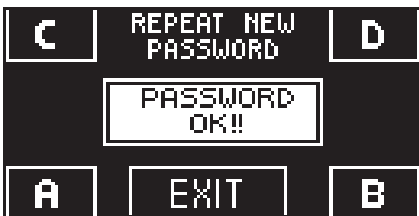

- If the password entered is correct, "PASSWORD OK" is displayed for one second and the system returns to the PASSWORD MANAGEMENT section.



Press the EXIT  button to return to the general programming menu.

If the password you entered does not match the previous one, the display shows PASSWORD ERROR, the system returns to the section PASSWORD MANAGEMENT, and it is necessary to perform again the procedure.

ENABLING USER PASSWORD USAGE (primary and service password)

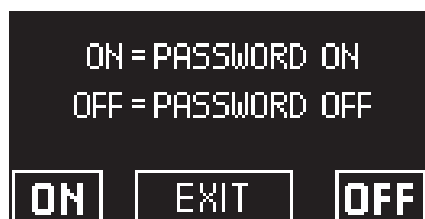
- Select "PASSWORD ON / OFF"
- Press OK (F1).



- Press the ON  button to enable the usage of user passwords and return to the menu PASSWORD MANAGEMENT. To return to the work program view, press the EXIT button twice .
- From this moment on, whenever the user wants to access the digital selector HB-DSEL to change the automatic door work program, the primary or service password must be entered.



When the user decides to enable password usage, it is recommended to change the combination of both primary and service password.

DISABLING USER PASSWORD USAGE

- From the PASSWORD MANAGEMENT section, select "PASSWORD ON / OFF"
- Press the button OK (F1)



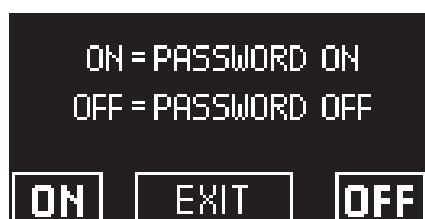

- Enter the primary password





- Press the OFF button (F1) to disable user password usage. To return to the general programming menu press twice the  button EXIT. Access to the digital selector HB-DSEL as program selector now is free.

4.2.3) LANGUAGE

To select the language perform the operations listed below:

1. Press and hold the button  for 5 seconds to access the general programming menu (see Diagram 1 in the previous paragraph)
2. Press the button **F1** three times to go to the "Language" sub-menu.
3. Press the Enter  button to access the section "Language".

- Use the buttons **F2** and  to move the arrow in correspondence with the desired language.
- Press the EXIT  button to return to general programming menu.
- Press the EXIT button  again to return to the main view of the automatic door work program.



4.2.4) SELECTOR OPTIONS

In the section "Selector Options" you can choose which work programs are displayed on the display of the digital selector, so that the end user can scroll through and select only those he wants to use, while the others are not displayed.

"Automatic bidirectional program"



The buttons in this sub-menu are used as follows:

The button * allows to go to the next selection.

The button F2 allows to return to the previous selection.

The button F1 sets the function state to OFF.

The button F3 sets the function state to ON.

"Exit Only Program"



"Entry Only Program"



"Open door program"



"Night lock program"



"Manual free door"



"Reduced opening during winter"



"Pharmacy opening"



5) OPERATION IN CASE OF POWER SUPPLY FAILURE

If the battery module is installed in the automation, automatic door operation is guaranteed by an emergency battery.

Depending on the programming of the automation electronic control unit, the door may operate as follows:

- Automatically open and stay open if the program selector is not set to Night Lock.
- The door stays closed, but it can be opened by activating any opening command (motion radars, buttons, etc.).

POWER SUPPLY LIGHT DISPLAY on HB-DSEL PROGRAMMER

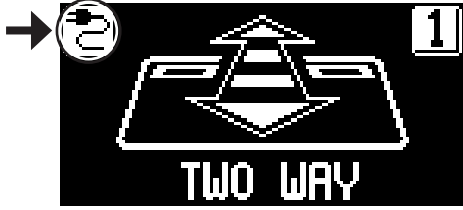

Mains power supply on and connected battery under charge.

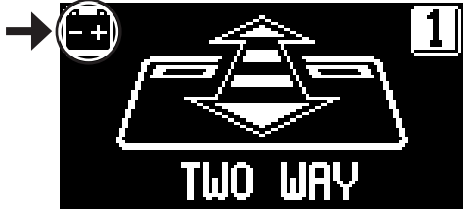

Mains power supply off and door operating with charged battery.

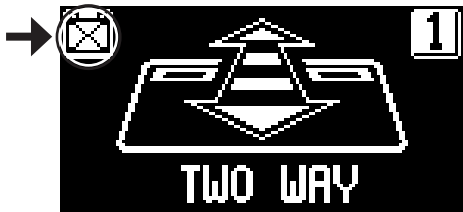

- Mains power supply off and door operating with battery low.
- Mains power supply on with inefficient battery.

- When the battery is exhausted or there is no emergency battery, door motion is free and leaves may be opened manually if the electric lock is not installed.
- If the electric lock is installed and the door is closed, leaves cannot be moved manually. In this case, to unlock the door, release the electric lock turning the MANUAL RELEASE knob clockwise by about 45° - 50° (see fig. below, position 2); under these conditions you can manually open the door.

1 LOCKED

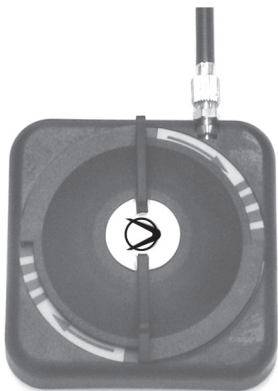

2 RELEASED

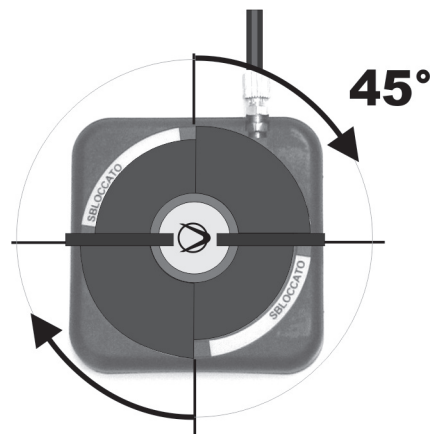

Remember to turn the MANUAL RELEASE knob back to position 1 LOCKED to restore the electric lock operation with mains power supply on.

6) NOTIFICATION OF ERRORS AND OPERATIONAL ISSUES

PROBLEM	LIKELY CAUSE	SOLUTION
The door opens but it doesn't close back.	The motion radars or the closing safety sensor detect the presence of an object or of a person.	Check that the radars or the sensors are not engaged.
The door opens very slowly.	The opening safety sensor detects an obstacle.	Identify the obstacle and remove it.
The door doesn't respond to the opening commands.	The MANUAL FREE DOOR function can be activated.	Check the setting of the program selector.
The door stops during its motion and inverts the running direction.	The door detects an obstacle along its motion.	Identify the obstacle and remove it.
	The door experiences friction along its motion.	Properly arrange the fixture; for this operation please contact the service centre.
The electronic control unit beeps multiple times and door operation is irregular.	The defect depends on the number and length of the beeps.	Contact the service centre to solve the issue.
The symbol  is displayed	The system has detected a machine operation error.	Contact the service centre to solve the issue.

Should any malfunction occur, the Customer must contact the Support Centre and use the door manually, without powering it.

7) MAINTENANCE

The maintenance plan must be observed to ensure the service life and the safe operation of the automatic door. It is recommended to sign a maintenance contract providing for periodic intervention on the system by specialised technicians.

If the user has the program selector HB-DSEL, he will be warned about the expiry of the maintenance interval when the message "PROGRAMMED MAINTENANCE" is displayed.

Each maintenance operation is recorded into the maintenance log. The final user must limit himself to cleaning the glass surfaces, the door profiles, and if necessary the motion and presence sensors, taking care to lock the door while performing these operations.



8) DISPOSAL

At the end of its lifecycle, this system must be disposed of in accordance with national provisions. To this purpose, it is recommended to contact specialised operators.

LABEL service centre

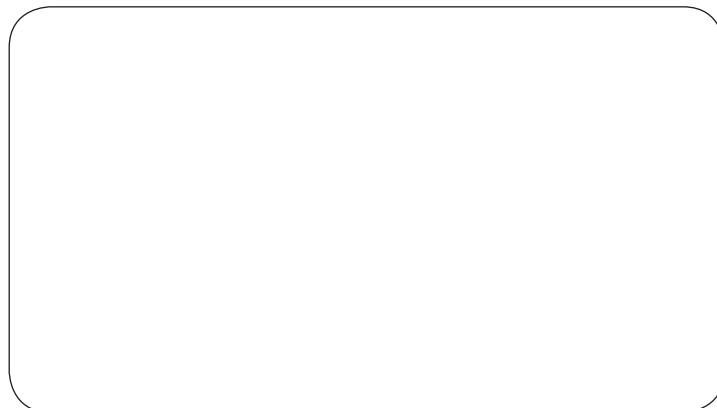

Made in Italy
by



Via Ilariuzzi, 17/A - S. Pancrazio P.se - 43126 PARMA - ITALIA
Tel. (+39) 05 21/ 67 52 - Fax (+39) 05 21/ 67 52 22
infocom@labelspa.it - www.labelspa.com



AZIENDA CERTIFICATA
SISTEMA QUALITÀ
UNI EN 9001:2008