

USER MANUAL

EVOLUS-TF 150TF 16005

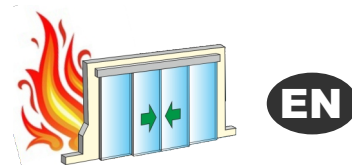

PEDESTRIAN FIRE AUTOMATIC SLIDING DOOR



Made in Italy by



English
TRANSLATION OF ORIGINAL INSTRUCTIONS

USER MANUAL - EVOLUS-150T(F) - FIRE DOOR - EN - Rel.1.8 - 12/2023
CD0666TF-MU

IMPORTANT NOTICE

THE PRESENT INSTRUCTION MANUAL IS MEANT FOR THE END USER OF A FIRE RATED AUTOMATIC SLIDING DOOR IN ORDER TO ACHIEVE A PROPER COMPARTMENT. IT IS UNDERSTOOD THAT THE INSTALLATION AND TEST HAVE ALREADY BEEN CARRIED OUT THROUGH SPECIALIZED PERSONNEL.

GENERAL SAFETY WARNINGS



BEFORE COMMISSIONING THE AUTOMATIC DOOR, PLEASE CAREFULLY READ THIS MANUAL.

PROVISIONS

The automatism has been designed to be used exclusively with pedestrian automatic sliding doors. The manufacturer accepts no responsibility for incorrect product usage, as well as for any damages arising from changes to the system made without his prior consent. When operating the system accident prevention regulations must be observed.

REMARKS

Always meet the usage and maintenance conditions. Maintenance and repair operations must only be performed by qualified and properly trained personnel.

PROPER BEHAVIOUR

Only use the automatic door if it is in perfect technical conditions. In case of failure or malfunction that might affect safety immediately contact the service centre. Inappropriate use of the system may cause serious injuries and damage.

TABLE OF CONTENTS:

| | | |
|--|------|----|
| 1) INDICATIVE SYSTEM DESCRIPTION | page | 4 |
| 2) TECHNICAL DATA | | 4 |
| 3) AUTOMATIC DOOR OPERATION | | 5 |
| 3.1) NORMAL DOOR OPERATION | | 5 |
| 3.2) DOOR OPERATION IN NIGHT LOCK MODE | | 5 |
| 4) DIGITAL PROGRAM SELECTOR N-DSEL | | 6 |
| 5) GENERAL PROGRAMMING MENU | | 7 |
| 5.1) PASSWORD | | 9 |
| 5.2) LANGUAGE | | 11 |
| 6) OPERATION IN CASE OF POWER SUPPLY FAILURE | | 12 |
| 7) NOTIFICATION OF ERRORS AND OPERATION PROBLEMS | | 13 |
| 8) MAINTENANCE | | 14 |
| 9) DISPOSAL | | 14 |

1) INDICATIVE SYSTEM DESCRIPTION

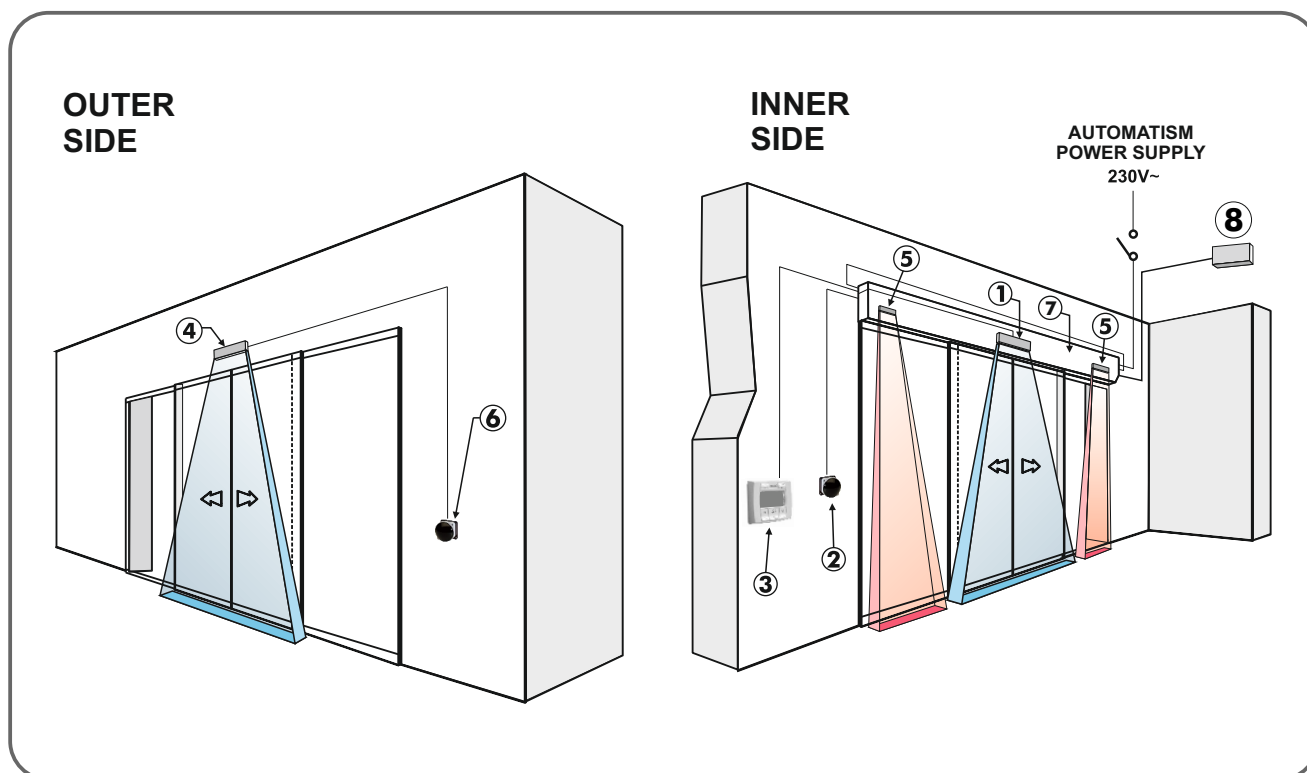

- ① Internal movement and presence sensor for door opening and safety during closing
- ② Opening switch button OPEN
- ③ Digital programmer
- ④ External movement and presence sensor for door opening and safety during closing
- ⑤ Opening safety sensor
- ⑥ Opening switch button OPEN
- ⑦ EVOLUS operator
- ⑧ Door closing input from the building fire system

2) TECHNICAL DATA

| | |
|--------------------------------------|------------------------|
| OPERATOR MODEL | EVOLUS-150T(F) |
| POWER SUPPLY | 230Vac +/-10%, 50-60Hz |
| POWER | 130W |
| FREQUENCY OF USE | continuous |
| PAUSE TIME | Max. 20 sec. |
| WORKING TEMPERATURE | -15°C +50°C |
| PROTECTION DEGREE | IP22 |
| POWER SUPPLY OF EXTERNAL ACCESSORIES | 13 Vdc |
| EVOLUS TRANSOM DIMENSIONS (H x D) | 120 x150 mm |

3) AUTOMATIC DOOR OPERATION

WARNING!!

Always contact the assistance technician before commissioning the door, to learn how the automation works.

Switch on the power supply by means of the system switch.

The automation electronic control unit beeps shortly to indicate that the automatic door is powered.

The first opening command starts a calibration cycle during which the door opening speed is very low until the end of the stroke, to find the stop point; after the delay time has elapsed, the door closes back at normal speed.

3.1) NORMAL DOOR OPERATION

When something enters the motions sensor (internal and/or external radar) detection area the door opens and stays open until sensors detect the presence, then once the pause delay has elapsed the door closes back.

When the manual door opening button is pressed the door opens and stays open until the command remains active, then once the pause delay has elapsed it closes back.

If the closing safety sensor detects a presence, the door immediately reopens, and stays open as long as the sensor remains engaged.

If the opening safety sensor detects a presence, the door slows down and proceeds very slowly until the opening stroke is completed.

If during the opening motion the door bumps against an obstacle, it stops and closes back.

When it opens again, later, it slows down near the point where it had met the obstacle, to avoid further impact.

If during the closing motion the door bumps against an obstacle, it stops and opens back.

When it closes again, later, it slows down near the point where it had met the obstacle, to avoid further impact.

FORCED CLOSING

If the door closing device trips, the door closes slowly and stays closed as long as the device remains active.

Under this condition the door can be opened using the OPEN control in MANNED mode; when the control is released, therefore, the door immediately closes back.

If installed, a warning device informs the user that the door status was caused by the tripping of the door closing device.

RESTORE OPERATION

After a forced closing, the door operation must be restored by selecting the NIGHT LOCK program first and then the TWO-WAY automatic program.

3.2) DOOR OPERATION IN NIGHT LOCK MODE

The door cannot be opened through the external and internal radars.

The door can only be opened by pressing the OPEN button, or using the Spyco radio-control, if any.

The safety function are active and work as described in par. 3.1. for normal operation.

4) DIGITAL PROGRAM SELECTOR N-DSEL



By pulse-pressing the  button, choose the automatic door operating mode. Each time a button is pressed, it switches from a work program to the next one.

The operating programs to be selected by  button are described below



Bi-directional automatic program

The door automatically opens when each opening control activates.



Single-direction automatic program output only

To exclude the incoming detection on external radar input



Single-direction automatic program input only

To exclude the outgoing detection on internal radar input.



Open door program

The door stops in complete opening position.



Night lock program

The door can only be opened through the OPEN input or using the remote control, if any.



Free manual door

The automatic operation is disabled and door can be manually open.

5) GENERAL PROGRAMMING MENU

The user can enter the general programming menu when he wishes to select the desired language for the texts that appear on the display, or when he wishes to enable a password to prevent any unauthorised access to the N-DSEL digital programmer.

DIAGRAM 1

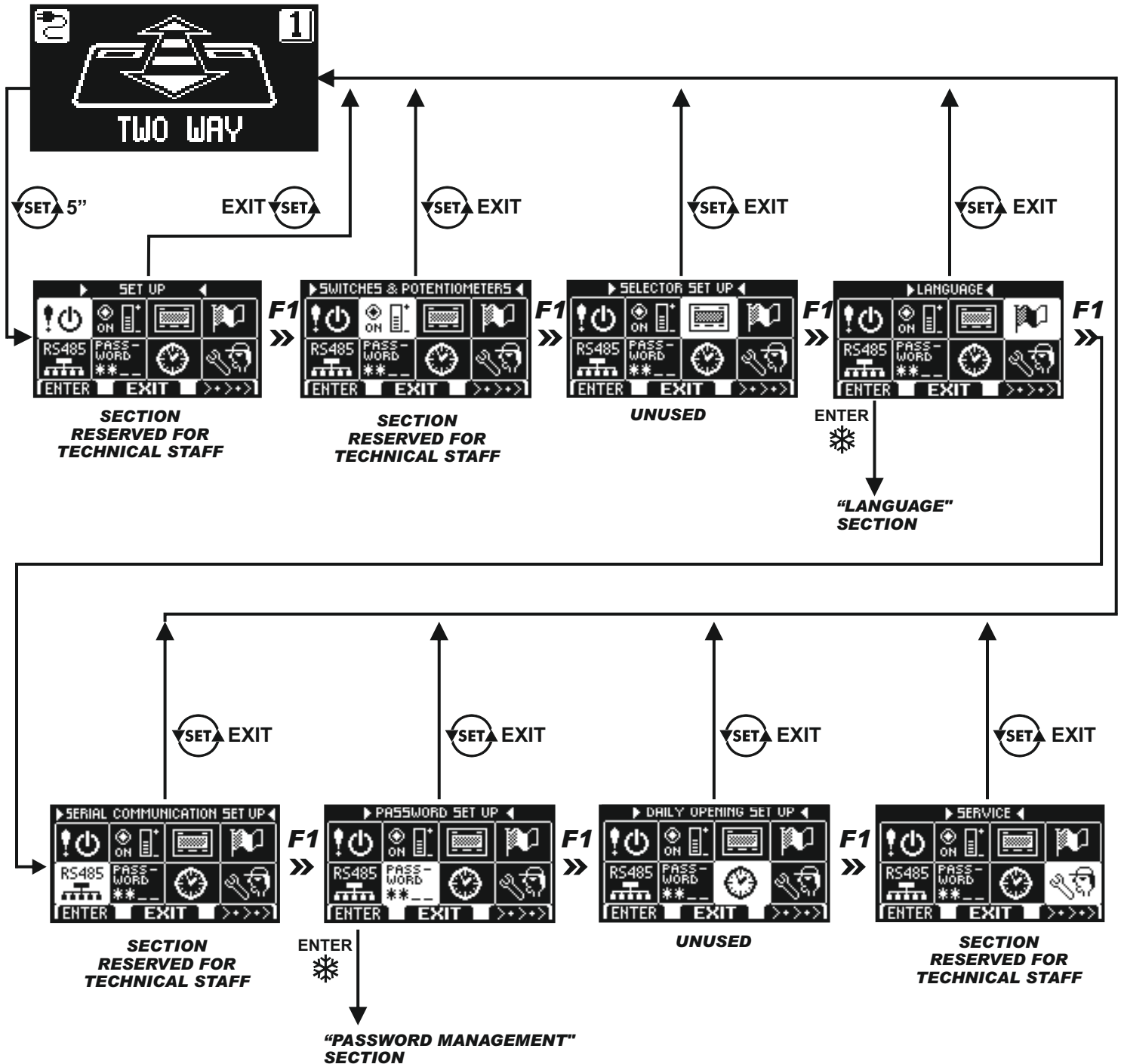

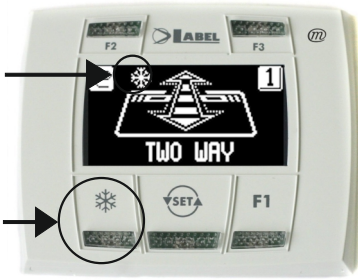

The paragraphs below explain the procedure to be followed to manage the user password and to select the language.

Operation of other buttons located on N-DSEL program selector panel



REDUCED OPENING DURING WINTER

To reduce the passage opening.

To activate the reduced opening during winter press the  button once; the  symbol on the display indicates that the function is on.

To disable the reduced opening during winter press the  button once more;

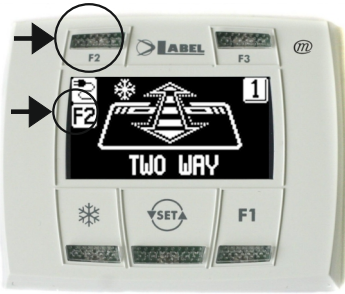

F2

UNUSED



F1

Door opening command

Pressing the F1 button will open the door.

The F1 may open the door even when the "NIGHT LOCK" work program is selected, if the operator electronic control unit is set accordingly.



F3

It is only used if the N-DSEL digital programmer manages two automatic doors

The N-DSEL digital programmer can independently manage the operation of two EVOLUS sliding automatic doors.

Pressing the F3 button allows to select the door on which the work program is set;



The number 1 appears on the display when door 1 is selected; the number 2 appears if door 2 is selected.

5.1) PASSWORD

To prevent the door work program from being modified, a password can be entered that must be input every time the N-DSEL programmer is used.

To enable the password perform the operations listed below:

1. Press the SET button for 5 seconds to access the general programming menu (see Diagram 1 at para. 4.3.1)
2. Press the F1 button five times to switch to the Password Management sub-menu.
3. Press the Enter  button to access the "Password management" section.

PASSWORD MANAGEMENT



This section displays the two passwords available to the final user, the primary password and the service password.

The technical password is only reserved for the technical staff members in charge of installation and maintenance operations.

PRIMARY PASSWORD (for the system's owner-user)

It is a 5-character password used by the user to prevent unauthorized persons from having access to N-DSEL programmer and change the work program.

Using a primary password is optional and must be enabled by system's owner.

Default preset primary password is "A-A-A-A-A".

WARNING!

When enabling the password, be careful not to forget the access combination.

SERVICE PASSWORD (for user)

It is a 5-character password that the system's owner may divulge to persons to be authorized to use N-DSEL programmer.

The service password only allows changing the automatic door work program.

Default preset service password is "A-A-A-A-A".

To change the service password, it is necessary to have access by primary password.

Use the  button to move the selection arrow downward, F2 button to move back upward.

HOW TO CHANGE THE PRIMARY PASSWORD

- Select "PRIMARY PASSWORD"
- Press OK (F1) button.



- Type the default preset primary password "A-A-A-A-A" by pressing 5 times on A button.
(IF the primary password is not the default password as it had already been changed before, type the currently-used primary password).



- Type the new primary password, selecting a combination of 5 characters from the letters A-B-C-D.



- It is required to repeat the new password, so type the previous combination again.

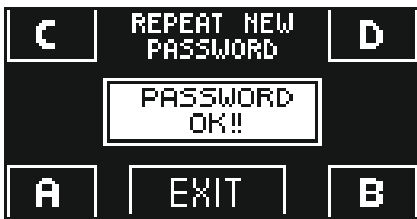

- If the typed password is correct the "PASSWORD OK" message appears on the display for one second, then the system switches back to the PASSWORD MANAGEMENT section; press the EXIT  button to return to the general programming menu
- If the typed password doesn't match the previous one, the PASSWORD ERROR message appears on the display; the system will switch back to the PASSWORD MANAGEMENT section and the user will have to repeat the procedure.

HOW TO CHANGE THE SERVICE PASSWORD

- Select "SERVICE PASSWORD".
- Press OK (F1) button.



- Type the primary password.



- Type the new service password, selecting a combination of 5 characters from the letters A-B-C-D.



- It is required to repeat the new password, so type the previous combination again.



- If the password typed is correct, "PASSWORD OK" is shown on display for one second and the system returns to the PASSWORD MANAGEMENT section.

Press the EXIT  button to return to general programming menu.

If the typed password doesn't match the previous one, the PASSWORD ERROR message appears on the display; the system will switch back to the PASSWORD MANAGEMENT section and the user will have to repeat the procedure.

ENABLING USER PASSWORD USAGE (primary and service)

- Select "PASSWORD ON / OFF"
- Press OK (F1) button.



- Press the ON button to enable the usage of user passwords and return to the PASSWORD MANAGEMENT menu. To return to the work program view press the EXIT button twice.
- From this moment on, whenever the user wants to access to N-DSEL digital programmer to change the automatic door work program, the primary or service password must be typed.

When the user decides to enable the password usage, it is recommended to change the combination of both primary and service password.

DISABLING USER PASSWORD USAGE

- From the PASSWORD MANAGEMENT section, select "PASSWORD ON / OFF"
- Press OK (F1) button.



- Type the primary password.

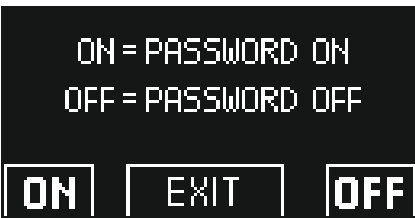

- Press the OFF button (F1) to disable user password usage. To return to the general programming menu press the EXIT button twice. From this moment on, the access to N-DSEL digital programmer like program selector is free.

5.2) LANGUAGE

To select the language perform the operations listed below:

1. Press the button for 5 seconds to enter the general programming menu. (see Diagram 1 in the previous paragraph)
2. Press the F1 button three times to switch to the Language sub-menu.
3. Press the Enter button to access the "Language" section.

- Use the F2 and buttons to move arrow to the desired language.
- Press the EXIT button to return to general programming menu.
- Press the EXIT button again to return to the main view of the automatic door work program.



6 - OPERATION IN CASE OF POWER SUPPLY FAILURE

If no mains power supply is available, the door closes using the power supplied by the battery and the leaf electric lock trips.

• POWER SUPPLY LIGHT DISPLAY ON N-DSEL PROGRAMMER

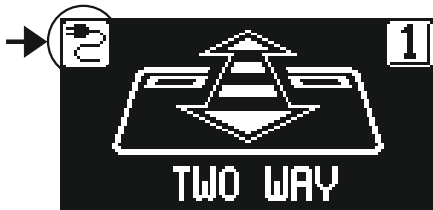

Mains power supply on and connected battery being charged.

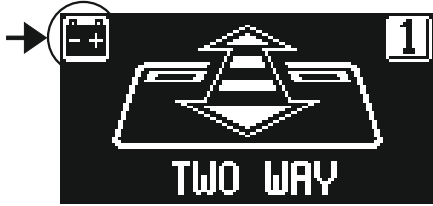

Mains power supply off

The door closes using the power supplied by the battery.

The door can be opened using the jog OPEN control; when it is released the door closes back.

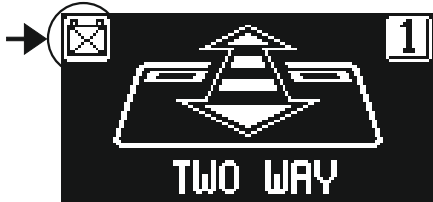

- Mains power supply off and door operating with almost exhausted battery. The door stays closed and the OPEN control isn't active.
- Mains power supply on with inefficient battery. The door closes and will stay closed.

- When the door is closed and electrically locked leaves cannot be moved manually.

In this case, to unlock the door, release the electric lock by turning the MANUAL RELEASE knob clockwise by about 45° - 50° (see fig. below, item ②); under these conditions you can manually open the door.

① LOCKED

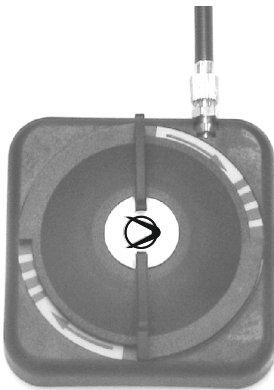

② RELEASED

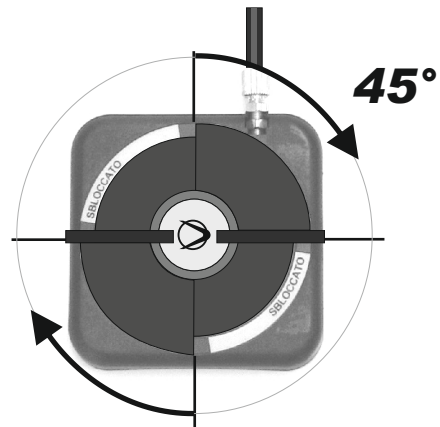

Remember to turn the MANUAL RELEASE knob back to position ① LOCKED to restore the electric lock operation with mains power supply on.

| PROBLEM | LIKELY CAUSE | SOLUTION |
|--|--|---|
| The door opens but it doesn't close back. | The motion radars or the closing safety sensor detect the presence of an object or of a person. | Check that the radars or the sensors are not engaged. |
| The door opens very slowly. | The opening safety sensor detects an obstacle. | Identify the obstacle and remove it. |
| The door doesn't respond to the opening commands. | The MANUAL FREE DOOR function can be activated. | Check the setting of the program selector. |
| The door stops during the stroke and inverts the running direction. | The door detects an obstacle along its stroke. | Identify the obstacle and remove it. |
| | The fixture experiences friction along its stroke. | Properly arrange the fixture; for this operation please contact the service centre. |
| The electronic control units beeps multiple times and door operation is irregular. | The defect depends on the number and length of the beeps. | Contact the service centre to resolve the problem. |
| The ⓘ symbol appears on the display | The system has detected a machine operation error. | Contact the service centre to resolve the problem. |
| The door is closed and doesn't open | The battery is not running and the damaged battery symbol ⓘ is shown on the display of the N-DSEL/TF programmer. | Contact the service centre to resolve the problem. |
| | The door closing device has tripped. | Check that the door closing device is no longer active and perform the restore operation. |

Should any malfunction occur, the Customer must contact the Support Centre and use the door manually, without powering it.

8 - MAINTENANCE

The maintenance plan must be observed to ensure the life and safe operation of the automatic door.

We recommend that you sign a maintenance contract providing for periodic intervention on the system by specialised technicians.

- The owner of the building is responsible for ensuring the immediate repair of any damage or performance decrease detected during the system useful life which may negatively affect the fire-resistant door performance.
- Special attention must be paid to the regular checking and periodic maintenance of the intumescent seals and gaskets, to ensure that their mechanical durability doesn't decrease and that there is no degradation caused by weather, chemical or biological agents;
- The owner of the building is responsible for ensuring that the maintenance program prescribed by the manufacturer is fully implemented, in compliance with the relevant specifications.

The message "SCHEDULED MAINTENANCE" will appear on the display if the installer enabled the number of door opening/closing cycles after which maintenance is recommended.

The user, anyway, must regularly comply with the prescribed maintenance plan.

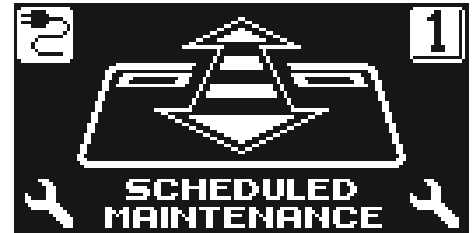

Each maintenance operation is recorded into the maintenance register.

The final user must limit himself to cleaning the glass surfaces, the fixture profiles and if necessary the motion and presence sensors, taking care to lock the door while performing these operations.

9 - DISPOSAL

At the end of its life, this system must be disposed of in accordance with national provisions.

To this purpose we recommend that you contact specialised operators.

Service centre

EVOLUS-TF

Made in Italy

by



Via Ilariuzzi, 17/A - S. Pancrazio P.se - 43126 PARMA - ITALIA
Tel. (+39) 05 21/ 67 52 - Fax (+39) 05 21/ 67 52 22
infocom@labelspa.it - www.labelspa.com



AZIENDA CERTIFICATA
SISTEMA QUALITA'
UNI EN ISO 9001:2000