

USER MANUAL

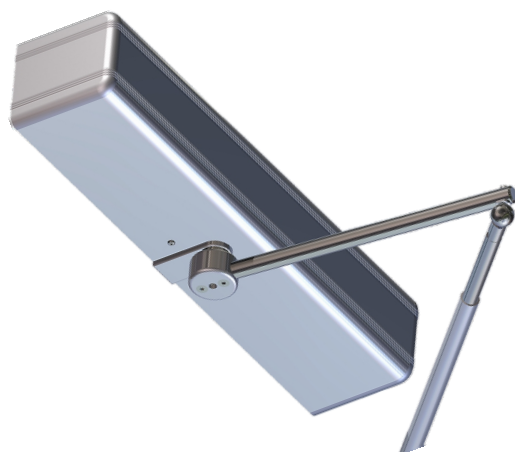

AUTOMATIC SWING DOORS FOR PEDESTRIANS

GB



Neptis

16005

**SLT-B
LET-B
SMT-B
SLT
LET
SMT**

Made in Italy by



AZIENDA CERTIFICATA
SISTEMA QUALITA'
UNI EN ISO 9001:2008

English
Translation of the ORIGINAL INSTRUCTIONS

RECOMMENDATIONS

THIS INSTRUCTION MANUAL IS INTENDED FOR THE FINAL USER OF A LABEL AUTOMATIC SWING DOOR SYSTEM; IT IS UNDERSTOOD THAT INSTALLATION AND TESTING MUST HAVE BEEN CARRIED OUT BY SPECIALISED PERSONNEL.

GENERAL SAFETY WARNINGS



BEFORE COMMISSIONING THE AUTOMATIC DOOR PLEASE CAREFULLY READ THIS MANUAL.

PROVISIONS

The automatism has been designed to be used exclusively with pedestrian automatic swing doors. The manufacturer accepts no responsibility for incorrect product usage, as well as for any damages arising from changes to the system made without his prior consent. When operating the system accident prevention regulations must be observed.

REMARKS

Always meet the usage and maintenance conditions provided for by LABEL. Maintenance and repair operations must only be performed by qualified and properly trained personnel.

PROPER BEHAVIOUR

Only use the automatic door if it is in perfect technical conditions. In case of failure or malfunction that might affect safety immediately contact the service centre. Inappropriate use of the system may cause serious injuries and damage.



AUTOMATIC SWING DOOR

Neptis

models: **SLT-B**
LET-B
SMT-B
SLT
LET
SMT

INDEX:

1) INDICATIVE SYSTEM DESCRIPTION	page	4
2) TECHNICAL DATA		4
3) AUTOMATIC DOOR OPERATION		5
3.1) NORMAL DOOR OPERATION		5
3.2) DOOR OPERATION IN NIGHT LOCK MODE		5
3.3) SUPPORT OPERATION FOR DISABLED PEOPLE		5
4) PROGRAM SELECTORS		6
4.1) MANUAL PROGRAM SELECTOR		6
4.2) EV-MSEL MECHANICAL KEY SELECTOR		6
4.3) N-DSEL DIGITAL PROGRAMMER - USED LIKE PROGRAM SELECTOR		7
4.3.1) GENERAL PROGRAMMING MENU		9
4.3.2) PASSWORD		10
4.3.3) LANGUAGE		12
5) OPERATION IN CASE OF POWER SUPPLY FAILURE		13
6) NOTIFICATION OF ERRORS AND OPERATION PROBLEMS		14
7) MAINTENANCE		15
8) DISPOSAL		15

1) INDICATIVE SYSTEM DESCRIPTION

NOTE:

The grey part indicates the survey zone of radar and sensors.

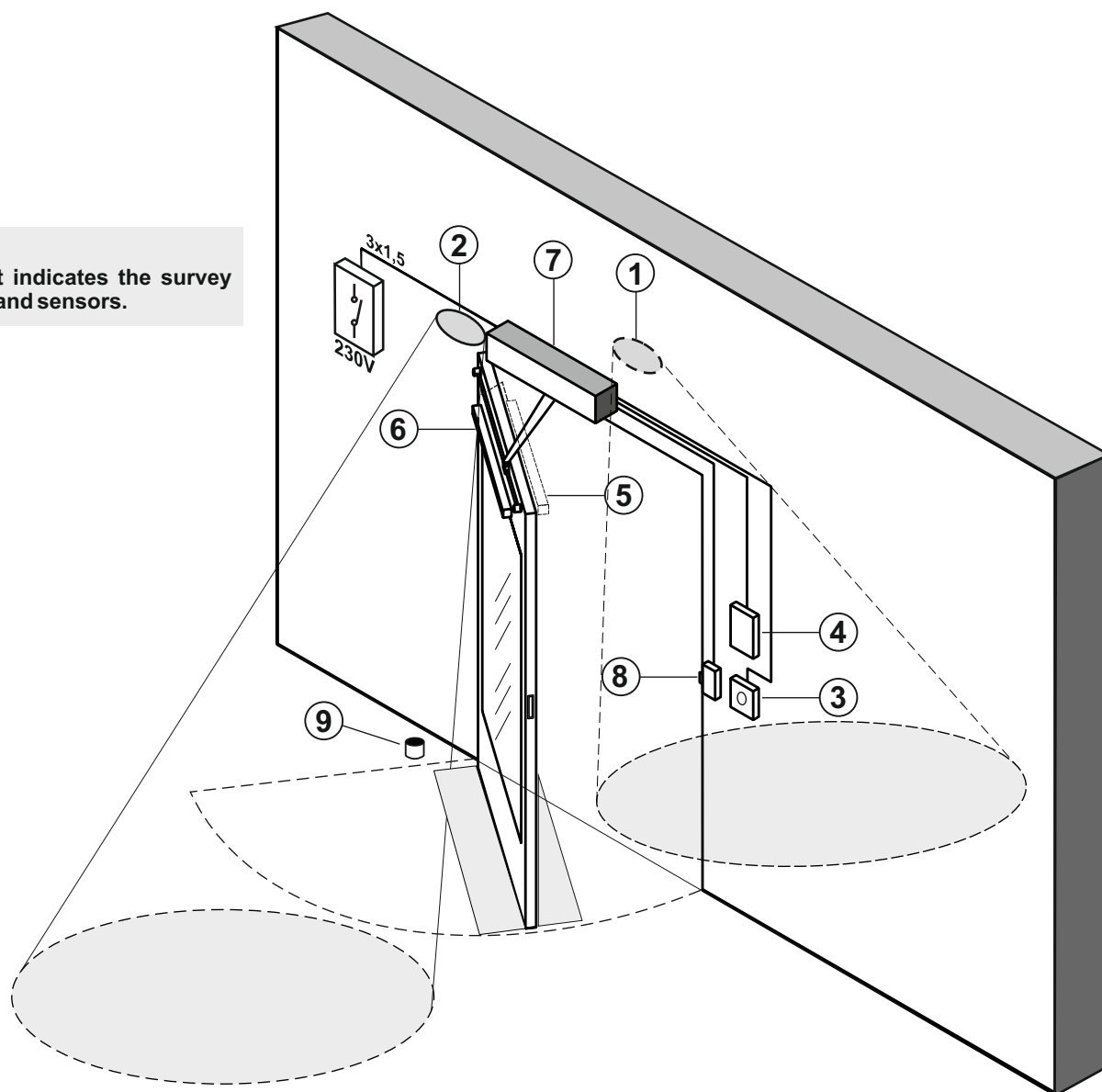

- ① EXTERNAL RADAR
- ② INTERNAL RADAR
- ③ OPENING BUTTON
- ④ PROGRAM SELECTOR
- ⑤ SAFETY SENSOR FOR CLOSING
- ⑥ SAFETY SENSOR FOR OPENING
- ⑦ NEPTIS OPERATOR
- ⑧ ELECTRIC LOCK
- ⑨ FLOOR STOP

2) TECHNICAL DATA

MODEL OPERATOR	SLT-B, LET-B, SMT-B, SLT, LET, SMT
POWER SUPPLY	115/230Vac +/-10%, 50-60Hz
POWER	120W
MAXIMUM WEIGHT OF DOOR WING	120 Kg (LET, LET-B), 250 Kg (SLT, SLT-B, SMT, SMT-B)
OPERATOR DIMENSIONS	550 x 120 x 110 mm
OPERATOR WITH BATTERY DIMENSIONS	730 x 120 x 110 mm
FREQUENCY OF USE	continuous
WORKING TEMPERATURE	-15°C +50°C
PROTECTION DEGREE	IP31
ELECTRIC MOTOR	24Vdc
POWER SUPPLY OF EXTERNAL ACCESSORIES	24Vdc

3) AUTOMATIC DOOR OPERATION

WARNING!!

Always contact the assistance technician before commissioning the door, to learn how the automation works.

Switch on the power supply by means of the system switch.

The automation electronic control unit beeps shortly to indicate that the automatic door is powered.

The first opening command starts a calibration cycle during which the door wing opening speed is very low until the end of the stroke, to find the stop points; after the delay set for the open door pause has elapsed, the wings close back at normal speed.

3.1) NORMAL DOOR OPERATION

- ◆ When something enters the motions sensor (internal and/or external radar) detection area the door opens and stays open until sensors detect the presence, then once the pause delay has elapsed the door closes back.
- ◆ When the manual door opening button is pressed the door opens and stays open until the command remains active, then once the pause delay has elapsed it closes back.
- ◆ If the electronic control unit has been programmed with the "push e go" function, you can also open the door with a brief manual push.
- ◆ If the safety sensor in closing detects the presence, the door immediately reopens and stays open as long as the sensor remains engaged.
- ◆ If the safety sensor in opening detects the presence, the door stops and doesn't move as long as the sensor is engaged; it will complete the opening cycle only after the sensors disengaged.

- ◆ If, during the opening motion the door bumps against an obstacle, it stops and closes back.
- ◆ If, during the opening motion the door bumps against an obstacle, it stops and opens back.

3.2) DOOR OPERATION IN NIGHT LOCK MODE

- The door cannot be opened through the motion sensors (radar).
- The door may only be opened by activating the OPEN button, or by the remote control Spyco if applicable.
- The safety function (sensors and behaviour in case of obstruction) are active and work as described in par. 3.1. for normal operation.

3.3) SUPPORT OPERATION FOR DISABLED PEOPLE

This only applies if the electronic control unit has been programmed and set to the disabled people operating mode.

- ◆ The disabled person may open the door through a special button or by motion sensor.
The door stays open for a delay time long enough to allow the disabled person to cross the door.
All the safety functions are on.

4) PROGRAM SELECTORS

The program selector allows the door user to select the operating mode.

The following can be used, according to the choice: manual selector integrated in Neptis operator side, EV-MSEL key mechanical selector or N-DSEL digital programmer.

Each program selector is described in details below.

4.1) MANUAL PROGRAM SELECTOR

The 3-position manual program selector is the basic solution provided for onboard operator.

- Position **I** = Bi-directional automatic program
The door automatically opens when each opening control activates.
- Position **0** = Free manual door
The automatic operation is disabled and door can be manually open.
- Position **II** = • Night lock program
The door can only be open by OPEN input or radio control, if applicable.
- Can have two different behavior, depending on the programming of the control unit.
- Open door program
The door stops in complete opening position.

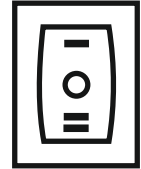



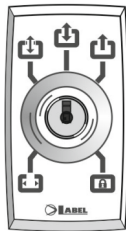

4.2) EV-MSEL MECHANICAL KEY SELECTOR



OPERATING MODE

Insert and rotate the key in EV-MSEL selector to select the program desired.

	Open door program The door stops in complete opening position.
	Free manual door The automatic operation is disabled and door can be manually open.
	Bi-directional automatic program The door automatically opens when each opening control activates.
	Single-direction automatic program output only To exclude the incoming detection on external radar input
	Night lock program The door can only be open by OPEN input or radio control, if applicable.

The key can be taken out of the selector when in any position in order to prevent the work program from undesired changes.

4.3) N-DSEL DIGITAL PROGRAMMER – USED LIKE PROGRAM SELECTOR

N-DSEL digital programmer can be installed in the system and used by the user like a program selector, as an alternative to manual and mechanical selector if you need a more complete tools in terms of functions and graphs.



Select the automatic door operating mode by pressing once the  button. Each time a button is pressed, it switches from a work program to the next one.

The operating programs to be selected by  button are described below



Bi-directional automatic program

The door automatically opens when each opening control activates.



Single-direction automatic program output only

To exclude the incoming detection on external radar input



Single-direction automatic program input only

To exclude the outgoing detection on internal radar input.



Open door program

The door stops in complete opening position.



Night lock program

The door can only be open by OPEN input or radio control, if applicable.



Free manual door

The automatic operation is disabled and door can be manually open.

Operation of other buttons located on N-DSEL program selector panel

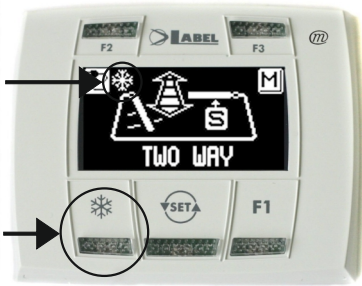

Pedestrian opening, used in double-leaf door automated device only
To activate pedestrian opening, press the ❄️ button.
the symbol ❄️ on the display indicates that the function is on.

In a double leaf door, the first leaf (Master) only opens if the opening command is given by internal or external radar inputs.

The pedestrian opening only operates in bi-directional, single-direction and open door automatic programs.

To deactivate pedestrian opening, press again the ❄️ button.

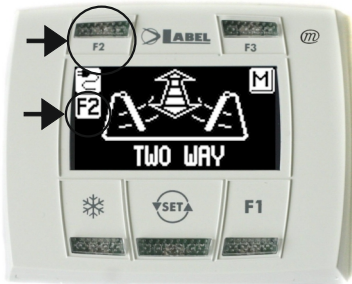

F2

Deactivation of step-by-step operation (if enabled in the setting of the operator)

Give a pulse to F2 button to deactivate the step-by-step operation and enable the door automatic closing. Symbol F2 on display goes ON.

Press F2 button again to activate step-by-step operation. Symbol F2 on display goes off.



F1

Door opening command

Press F1 button to open the door, in bidirectional and single directional programs.

The F1 button can open the door also in the NIGHT LOCK program (depend by the setting of the operator).

4.3.1) GENERAL PROGRAMMING MENU

The user can enter in the programming menu general when he wants to choose the preferred language in which to view texts that appear on the display, or when he wants to enable a password to prevent access to the use of N-DSEL digital programmer.

DIAGRAM 1

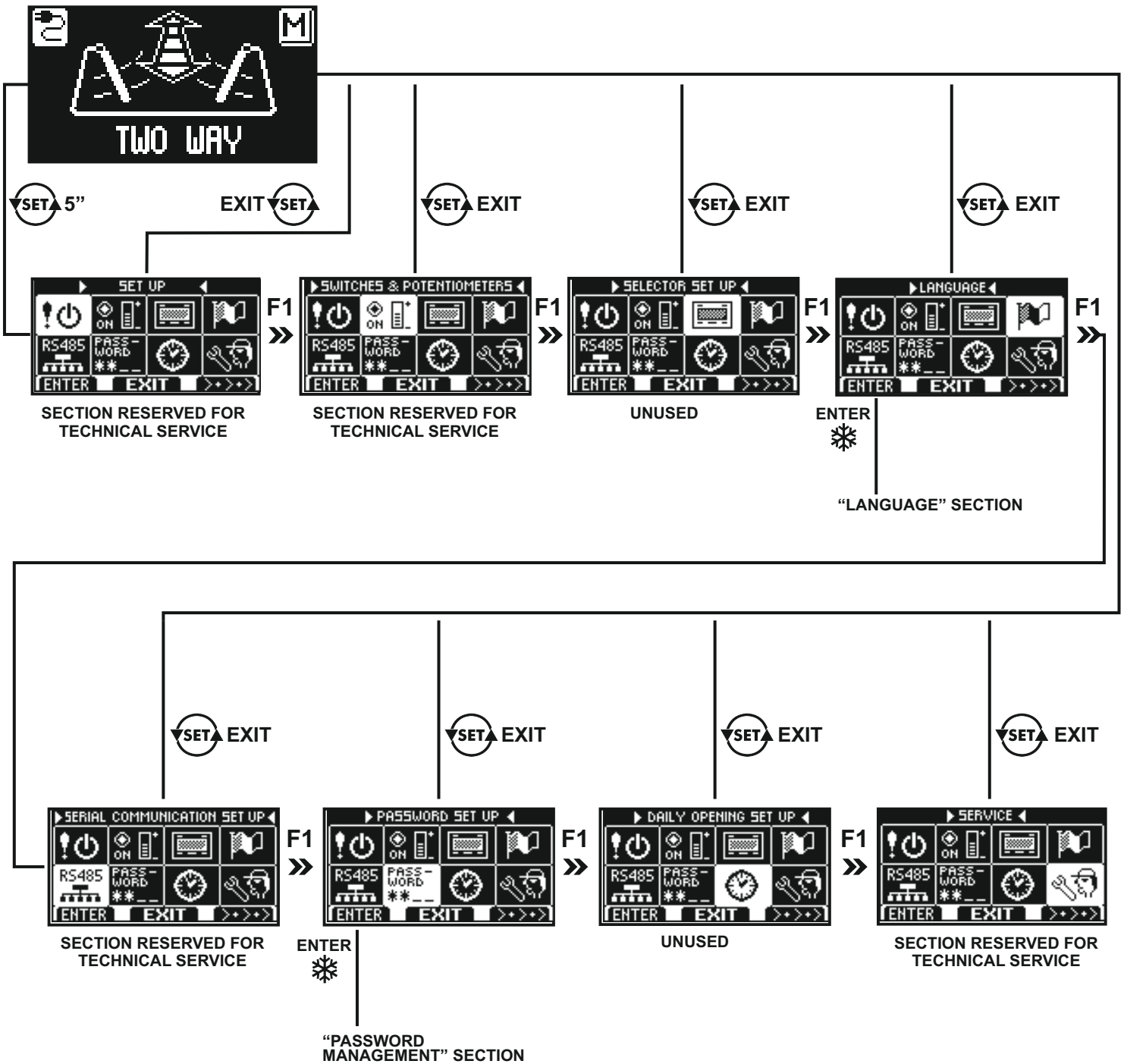

In the following sections explain how to manage user passwords and how to select the language.

4.3.2) PASSWORD

To prevent changes in the work program of the door, you can set a password that must be entered each time you act on the N-DSEL programmer.

To enable the password, do the following:

1. Press the SET button for 5 second to enter the programming menu general (see Diagram 1 in par. 4.3.1)
2. Press the F1 button five times to move to the submenu Password Manager.
3. Press the Enter button  to enter the "Password Management".

PASSWORD MANAGEMENT



In this section are two passwords that can be used by the end user, the primary password and password service.

The technical password is reserved only to the technical personnel responsible for installation and maintenance.

PRIMARY PASSWORD (for the system's owner-user)

It is a 5-character password used by the user to prevent unauthorized persons from having access to N-DSEL programmer and change the work program.

Using a primary password is optional and must be enabled by system's owner.

Default preset primary password is "A-A-A-A-A".

WARNING!

When enabling the password, be very careful not to forget the access combination.

SERVICE PASSWORD (for user)

It is a 5-character password that the system's owner may divulge to persons to be authorized to use N-DSEL programmer.

The service password only allows changing the automatic door work program.

Default preset service password is "A-A-A-A-A".

To change the service password, it is necessary to have access by primary password.

Use  button to move the selection arrow downward, F2 button to move the arrow upward.

HOW TO CHANGE THE PRIMARY PASSWORD

- Select "PRIMARY PASSWORD"
- Press OK (F1) button.



- Type the default preset primary password "A-A-A-A-A" by pressing 5 times on A button.



- Type the new primary password, selecting a combination of 5 characters from the letters A-B-C-D.



- It is required to repeat the new password, so type the previous combination again.



- If the password typed is correct, "PASSWORD OK" is shown on display for one second, thus reverting to the PASSWORD MANAGEMENT section; through the EXIT ^{SETA} button the general programming menu is restored.
- On the contrary, if the password typed does not match the previous one, PASSWORD ERROR is displayed, thus reverting to PASSWORD MANAGEMENT section. The procedure needs to be carried out again.

HOW TO CHANGE THE SERVICE PASSWORD

- Select "SERVICE PASSWORD"
- Press OK (F1) button.



- Type the primary password



- Type the new service password, selecting a combination of 5 characters from the letters A-B-C-D.



- It is required to repeat the new password, so type the previous combination again.



- If the password typed is correct, "PASSWORD OK" is shown on display for one second, thus reverting to PASSWORD MANAGEMENT section.

Pressing the EXIT ^{SETA} button the general programming menu is available again.

If the password typed does not match the previous one, PASSWORD ERROR is displayed, thus reverting to PASSWORD MANAGEMENT section. The procedure needs to be carried out again.



ENABLING USER (primary and service) PASSWORD USAGE

- Select "PASSWORD ON/OFF"
- Press OK (F1) button.

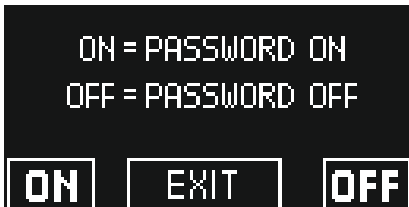

- Type the primary password



- Press ON  button to enable the user password usage and return to PASSWORD MANAGEMENT menu. To return to work program view, press EXIT  button twice.
- From this moment on, whenever the user wants to access to N-DSEL digital programmer to change the automatic door work program, the primary or service password must be typed.

 When the user decides to enable the password usage, it is recommended to change the combination of both primary and service password.

DEACTIVATING THE USER PASSWORD USAGE

- From PASSWORD MANAGEMENT section, type "PASSWORD ON/OFF"
- Press OK (F1) button



- Type the primary password

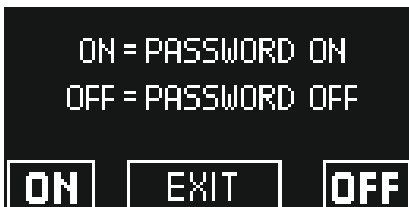



- Press OFF (F1) button to disable user password usage.
- To return to general programming menu press the EXIT  button twice.
- From this moment on, the access to N-DSEL digital programmer as program selector is free.

4.3.3) LANGUAGE

To select the language, do the following:

1. Press the SET button for 5 second to enter the programming menu general (see Diagram 1 in par. 4.3.1)
2. Press the F1 button three time to move to the submenu Language.
3. Press the Enter button  to enter the "Language section".



- Use F2 and  buttons to move arrow to the language desired.
- Press EXIT  button to return to general programming menu.

Press the EXIT button  to return to work program view of the automatic door

5) OPERATION IN CASE OF POWER SUPPLY FAILURE

- **NEPTIS SLT, LET VERSIONS**

In case of power supply failure the automation equipment only operates as a door closing device.
The door can be opened manually, while the closing cycle is performed through the incorporated closing spring.

- **NEPTIS SMT VERSION**

In case of power supply failure the door can be opened and closed manually.

If the door is equipped with an electric lock, use the special key to unlock it.

- **NEPTIS SLT-B, LET-B, SMT-B VERSION**

In these operators, the operation of the door in absence of main power supply is ensured by the battery.

Depending on the programming of the automation, the door may operate as follows:

- a) Automatically open and stay open if the program selector is not set to Night Lock.
- b) The door stays closed, but it can be opened by activating any opening command (motion sensors, buttons, etc.).

- **POWER SUPPLY LIGHT DISPLAY ON N-DSEL PROGRAMMER**

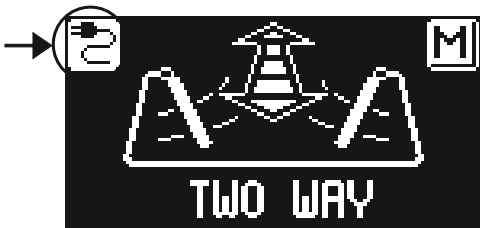

Mains power supply on and connected battery being charged

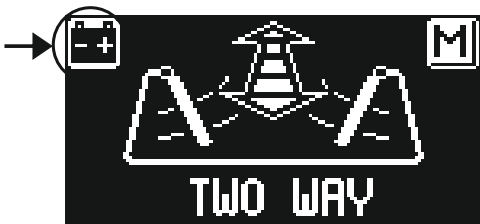

Mains power supply off and door operating with charged battery



- Mains power supply off and door operating with almost exhausted battery
- Mains power supply on with inefficient battery.

When the battery is exhausted, the behavior of the operator will be the same as the models SLT, LET, SMT.

6) NOTIFICATION OF ERRORS AND OPERATION PROBLEMS

PROBLEM	LIKELY CAUSE	SOLUTION
The door opens but it doesn't close back.	The motion sensors (radars) or the closing safety sensor detect the presence of an object or of a person.	Check that the radars or the sensors are not engaged.
The door doesn't complete the opening cycle and stops along the way.	The opening safety sensor detects an obstacle.	Identify the obstacle and remove it.
The door doesn't respond to the opening commands.	The FREE MANUAL DOOR function can be activated.	Check the setting of the program selector.
The door stops during the stroke and inverts the running direction.	The door detects an obstacle along its stroke.	Identify the obstacle and remove it.
	The fixture experiences friction along its stroke.	Properly arrange the fixture; for this operation please contact the service centre.
The electronic control units beeps multiple times and door operation is irregular.	The defect depends on the number and length of the beeps.	Contact the service centre to resolve the problem.
The display shows the symbol 	The system has detected an error in the operation of the machine.	Contact the service centre to resolve the problem.

In all cases of malfunction, the customer must contact the service centre and use the door manually without power supply.

7) MAINTENANCE

The maintenance plan must be observed to ensure the life and proper operation of the automatic door. It is recommended to take a maintenance contract that providing for periodic intervention on the system by specialised technicians.

If the user has the program selector N-DSEL, will be advised of the need for maintenance when the display shows the message "SCHEDULED MAINTENANCE". In this case, contact the authorized service center.

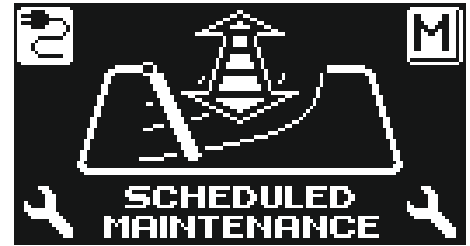

Each maintenance operation is recorded into the maintenance register. The final user must limit himself to cleaning the glass surfaces, the fixture profiles and if necessary the motion and presence sensors, taking care to lock the door while performing these operations.

8) DISPOSAL

At the end of its life, this system must be disposed of in accordance with national provisions. To this purpose we recommend that you contact specialised operators.

WARNING!

While uninstalling the operators with incorporated spring lock the spring using the special screw before removing the arm; **the spring pre-tensioning may result in an danger!**

Service centre

Neptis

Made in Italy
by



Via Ilariuzzi, 17/A - S. Pancrazio P.se - 43126 PARMA - ITALIA
Tel. (+39) 05 21/ 67 52 - Fax (+39) 05 21/ 67 52 22
infocom@labelspa.it - www.labelspa.com



AZIENDA CERTIFICATA
SISTEMA QUALITA'
UNI EN ISO 9001:2000