

# USER MANUAL

# AUTOMATIC DOORS FOR PEDESTRIANS



Butterfly  
**HOSPITAL**  
***EVOLUS - EVOLUS-T***  
Neptis



Made in Italy by



**AUTOMATIC SLIDING DOOR**

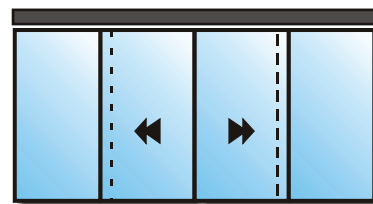

## ***EVOLUS - EVOLUS-T***

**AUTOMATIC SLIDING DOOR**

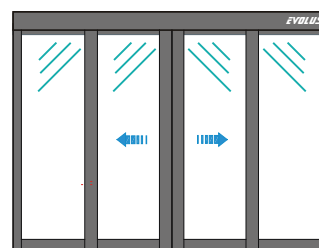

**TELESCOPIC AUTOMATIC DOOR**

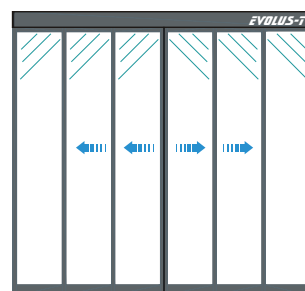

## **HOSPITAL**

**AUTOMATIC SLIDING DOOR  
FOR HOSPITALS**

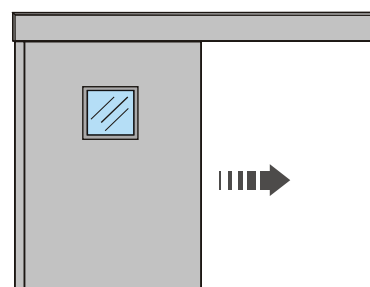

## **Neptis**

**AUTOMATIC LEAF DOOR**

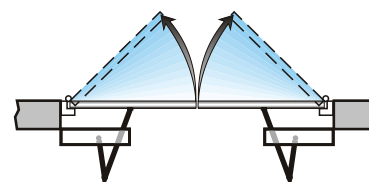

## **RECOMMENDATIONS**

---

---

THIS INSTRUCTION MANUAL IS INTENDED FOR THE FINAL USER OF A LABEL AUTOMATIC SLIDING DOOR SYSTEM; IT IS UNDERSTOOD THAT INSTALLATION AND TESTING MUST HAVE BEEN CARRIED OUT BY SPECIALISED PERSONNEL.

## **GENERAL SAFETY WARNINGS**

---

---



**BEFORE COMMISSIONING THE AUTOMATIC DOOR PLEASE CAREFULLY READ THIS MANUAL.**

## **PROVISIONS**

The automatism has been designed to be used exclusively with pedestrian automatic doors. The manufacturer accepts no responsibility for incorrect product usage, as well as for any damages arising from changes to the system made without his prior consent. When operating the system accident prevention regulations must be observed.

## **REMARKS**

Always meet the usage and maintenance conditions provided for by LABEL. Maintenance and repair operations must only be performed by qualified and properly trained personnel.

## **PROPER BEHAVIOUR**

Only use the automatic door if it is in perfect technical conditions. In case of failure or malfunction that might affect safety immediately contact the service centre. Inappropriate use of the system may cause serious injuries and damage.

## **PART 1: AUTOMATIC SLIDING DOOR**

### **TABLE OF CONTENTS:**

1 - INDICATIVE SYSTEM DESCRIPTION	page	5
2 - TECHNICAL DATA		5
3 - AUTOMATIC DOOR OPERATION		6
3.1 - NORMAL DOOR OPERATION		6
3.2 - DOOR OPERATION IN NIGHT LOCK MODE		6
4 - SELECTING THE BUTTERFLY WORK PROGRAM		7
4.1 - DIGITAL SELECTOR PS-1		7
4.2 - MANUAL SELECTORS SMB - SCB		8
5 - SELECTING THE EVOLUS - EVOLUS-T - HOSPITAL EVH, EVH-E WORK PROGRAM		9
5.1 - DIGITAL PROGRAMMER EV-SDEL		9
5.2 - MECHANICAL KEY SELECTOR EV-MSEL		13
6 - OPERATION IN CASE OF POWER SUPPLY FAILURE BUTTERFLY		14
7 - OPERATION IN CASE OF POWER SUPPLY FAILURE EVOLUS - EVOLUS T - HOSPITAL EVH, EVH-E		15
8 - NOTIFICATION OF ERRORS AND OPERATION PROBLEMS		17
9 - MAINTENANCE		18
10 - DISPOSAL		18

## 1 - INDICATIVE SYSTEM DESCRIPTION

- ① **AUTOMATION**
- ② **MOTION SENSOR (internal and external radar)**
- ③ **EMERGENCY OPENING BUTTON**
- ④ **PROGRAM SELECTOR**
- ⑤ **SAFETY PHOTOCELLS**
- ⑥ **EXTERNAL KEY BUTTON**
- ⑦ **MANUAL EMERGENCY RELEASE (only if the electric lock is installed)**

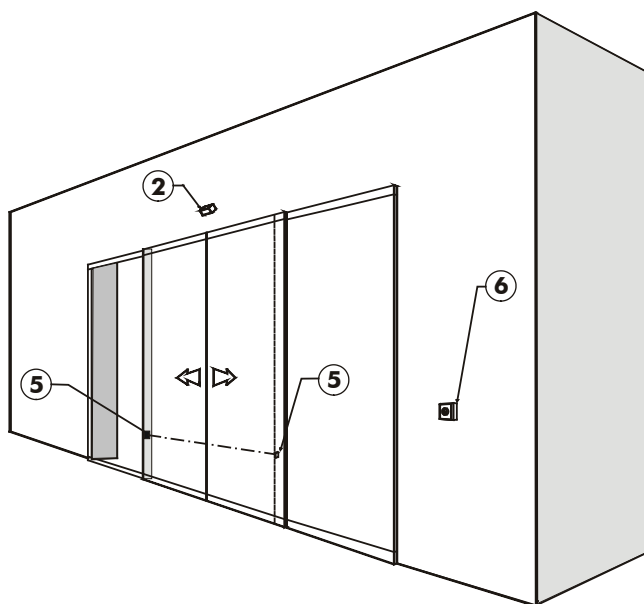

**OUTER VIEW**

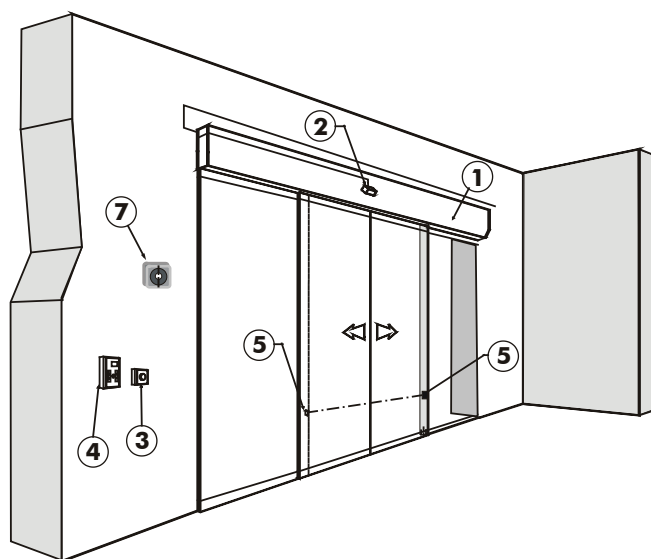

**INNER VIEW**

## 2 - TECHNICAL DATA

<b>POWER SUPPLY</b>	230V ac +/- 10%, 50-60 Hz
<b>POWER</b>	130W
<b>WORK TYPOLOGY</b>	Continuous 100%
<b>WORKING TEMPERATURE</b>	- 20° C / + 50° C

### 3 - AUTOMATIC DOOR OPERATION

---

---

#### **WARNING!!**

Always contact the assistance technician before commissioning the door, to learn how the automation works.

Switch on the power supply by means of the system switch.

The automation electronic control unit beeps shortly to indicate that the automatic door is powered.

The first opening command starts a calibration cycle during which the door wing opening speed is very low until the end of the stroke, to find the stop points; after the delay set for the open door pause has elapsed, the wings close back at normal speed.

#### 3.1 - NORMAL DOOR OPERATION

---

---

- ◆ When something enters the motions sensor (internal and/or external radar) detection area the door opens and stays open until sensors detect the presence, then once the pause delay has elapsed the door closes back.
- ◆ When the manual door opening button is pressed the door opens and stays open until the command remains active, then once the pause delay has elapsed it closes back.
- ◆ When something interrupts the safety photocell rays during closing, the door immediately reopens and stays open as long as the photocell remains engaged.
- ◆ If during the opening motion the door bumps against an obstacle, it stops and closes back.
- ◆ When it opens again, later, it slows down near the point where it had met the obstacle, to avoid further impact.
- ◆ If during the closing motion the door bumps against an obstacle, it stops and opens back.
- ◆ When it closes again, later, it slows down near the point where it had met the obstacle, to avoid further impact.

#### 3.2 - DOOR OPERATION IN NIGHT LOCK MODE

---

---

- ◆ The door cannot be opened through the motion sensors (radar).
- ◆ The door may only be opened by activating the emergency opening button (if the control unit has been suitably programmed).
- ◆ The safety function (photocells and behaviour in case of obstruction) are active and work as described in par. 3.1. for normal operation.

## 4 - SELECTING THE BUTTERFLY WORK PROGRAM

To select the automatic door work program use the selector installed in the system.

The LABEL range includes three models: the PS1 digital selector and the SMB and SCB manual selectors.





### 4.1 - PS1 DIGITAL SELECTOR

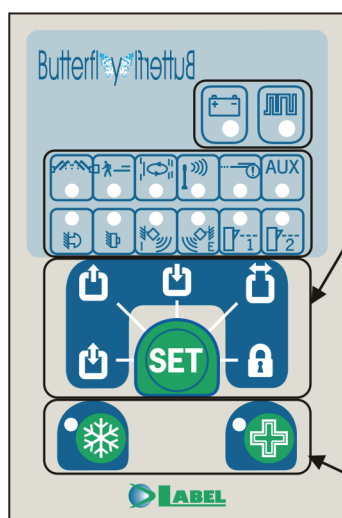

Turn the key switch to FREE FUNCTIONS  using the special supplied key.

By pushing the central button  select the automatic door work mode among the 5 available ones:



-  The door opens by activating any installed opening control.
-  The external radar is deactivated, all other opening controls remain active.
-  The internal radar is deactivated, all other opening controls remain active.
-  The door opens and remains open permanently.
-  The door stays closed and the radars are not enabled.  
The door can only be opened by using the EMERGENCY opening button, or the SPYCO/1E\* radio control

\* optional

#### REDUCED OPENING SELECTION:













Press the  button to reduce the passage opening (winter opening). The led on, on the button, indicates that the function is on irrespective of the selected operation program.

Press the  button to reduce the passage opening to about 10 cm (chemist's opening). When the button led is on the function is enabled. When this function is enabled and the chemist's electric lock is installed, the leaves are mechanically locked at the opening distance to prevent any intrusion attempts.

If you wish to prevent any changes to the set function, turn the key switch to LOCKED FUNCTIONS 

The table below describes the meaning of each warning lamp existing on the front panel of the digital selector; these lamps are associated with the controls and the safety devices installed in the automatic door system.

During normal operation the warning lights are off and only turn yellow when the relevant device is activated.

	Emergency input		Photocell 3 input
	Start input		Pedestrian opening input
	Internal radar input		Interlock input
	External radar input		SPYCO remote control input
	Photocell 1 input		Side sensor input
	Photocell 2 input		Auxiliary input

## 4.2 - MANUAL SELECTORS SMB - SCB

The SMB selector is equipped with a knob allowing to select the work program, while the SCB selector is equipped with a key switch allowing to lock the selected function by removing the key.

### SMB

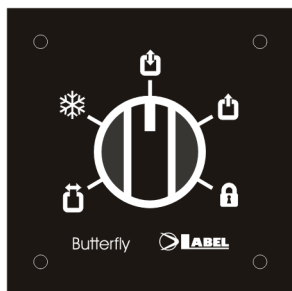



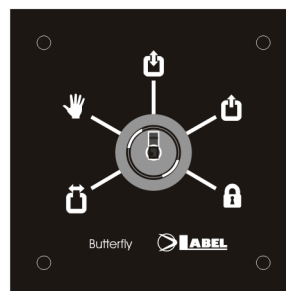

### SCB



## OPERATING MODE

Turn the knob of the SMB selector or the key of the SCB selector to select the desired function among the 5 available ones:

-  **DOOR ALWAYS OPEN** = to keep the door fully open.  
Starting the door opening with the selector turned to WINTER OPENING and immediately switching the knob to DOOR ALWAYS OPEN, the door stops in the winter opening position.
-  **WINTER OPENING** = to get a reduction of the opening space
-  **TWO-WAY TRAFFIC** = to open the door by means of all the control inputs
-  **OUTGOING TRAFFIC ONLY** = to exclude the incoming detection (EXTERNAL RADAR)
-  **NIGHT LOCK** = to keep the door closed, allowing its opening only by means of the EMERGENCY opening button



## 5 - SELECTING THE EVOLUS - EVOLUS-T, HOSPITAL EVH, EVH-E WORK PROGRAM

To select the automatic door work program use the selector installed in the system. The LABEL range includes two models:

the **EV-DSEL** digital programmer and the **EV-MSEL** mechanical key selector.

### 5.1 - DIGITAL PROGRAMMER EV-DSEL

By pushing the central button  select the automatic door work mode.  
Each time a button is pressed, it switches from a work program to the next one.  
The various available programs are described below.

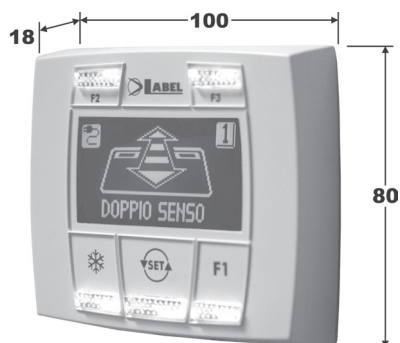



The door opens by activating any installed opening control.



The external radar is deactivated, all other opening controls remain active.



The internal radar is deactivated, all other opening controls remain active.



The door opens and remains open permanently.



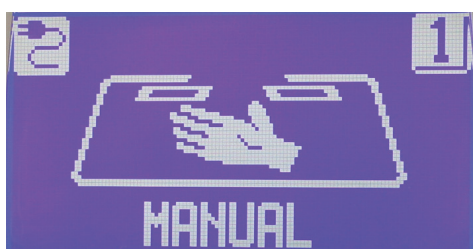

The door is closed and the radars are not active. The door may only be opened with the Emergency opening button.

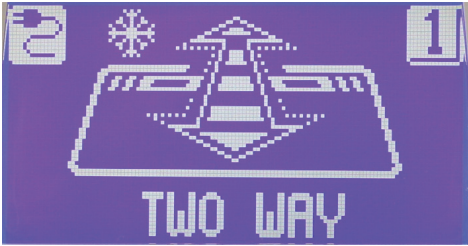

The door's automatic mode is deactivated and the leaves can be moved manually.

## REDUCED OPENING



Press the  button to reduce the passage opening.

The  symbol on the display indicates that the function is enabled. To disable the reduced opening function press the same button again.

## PASSWORD

To prevent the set function from being modified, a password can be entered that must be input every time the digital programmer is used.

### WARNING!

When enabling the password, be careful not to forget the access combination.

To enable the password, follow the steps described below.



From the work program display, press the  button for 8 seconds. The programming menu will appear on the display.

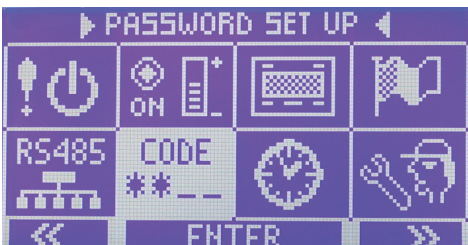

Press the button  until accessing the CODE item, corresponding to the password section.

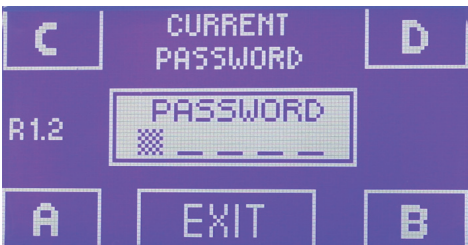

Briefly press the  button to access password selection. The current password is requested.



Enter the default password provided by LABEL with all digital programmers. The default LABEL password is composed of 5 characters and is A-A-A-A-A. Press the button in correspondence of the letter "A" and an asterisk will appear on the display in the field for the first letter.

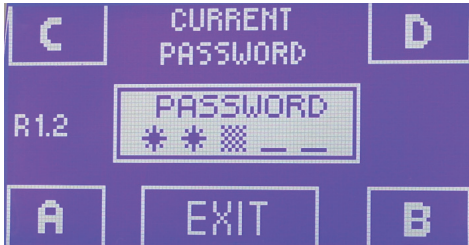

Press the button in correspondence of the letter "A" a second time, and an asterisk will appear on the display in the field for the second letter.



Press the button in correspondence of the letter "A" a third time and an asterisk will appear on the display in the field for the third letter.

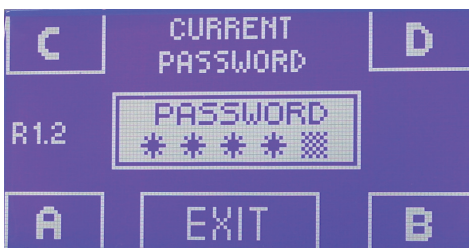

Press the button in correspondence of the letter "A" a fourth time, and an asterisk will appear on the display in the field for the fourth letter.

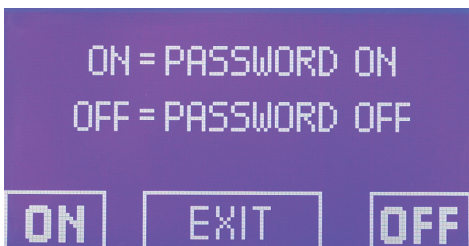

Press the button in correspondence of the letter "A" a fifth time and a screen will appear on the display that asks whether to enable the password "ON" or disable the password "OFF" (if the button in correspondence of OFF is pressed, you will exit password selection and return to the programming menu)



If the ON button is pressed, a screen will appear on the display where the new password is requested. Now enter the desired password, selecting a combination of 5 characters from the letters A-B-C-D. To select the letters, press the button in correspondence of the letter itself.



After entering the password the first time, the combination must be repeated a second time. Enter the previous password again.

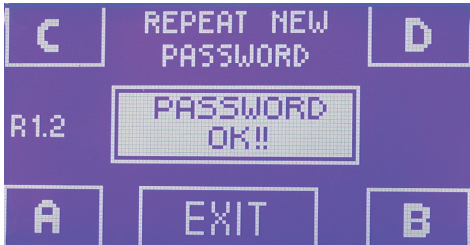

If the entered password is correct, the message "PASSWORD OK!!" will appear on the display.

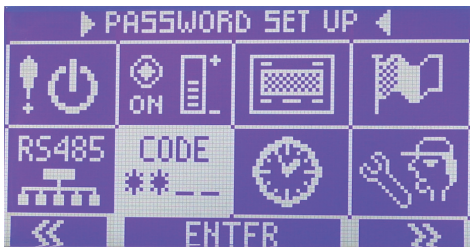

The system will now automatically return to the main programming menu.



Press the  button for 3 seconds to exit the programming menu and return to the main work programming selection screen.

At this point, the password will be requested each time that the work program must be changed. Simply enter the selected combination to use the digital programmer. To change the password or disable it, repeat the previous operations.

## 5.2 MECHANICAL KEY SELECTOR EV-MSEL







The **EV-MSEL** key mechanical selector allows to set up the work program of the **EVOLUS** automatic door.

It is equipped with a key switch allowing to lock the selected function by removing the key.

### OPERATING MODE

Input and turn the key of the EV-MSEL selector to select the desired function among the 5 available functions:

-  **DOOR ALWAYS OPEN** = to keep the door open.
-  **WINTER OPENING** = to get a reduction of the opening space
-  **TWO-WAY TRAFFIC** = to open the door by means of all the control inputs
-  **OUTGOING TRAFFIC ONLY** = to exclude the incoming detection (EXTERNAL RADAR)
-  **NIGHT LOCK** = to keep the door closed, allowing its opening only by means of the EMERGENCY input



The key can be taken out of the selector when in any position in order to prevent the work program from undesired changes.

## 6 - OPERATION IN CASE OF POWER SUPPLY FAILURE BUTTERFLY

If the KB-1A optional module is installed, automatic door operation is guaranteed by an emergency battery. Depending on the programming of the automation electronic control unit, the door may operate as follows:

- a) Automatically open and stay open if the program selector is not set to Night Lock.  
If the program selector is turned to NIGHT LOCK the door stays closed and can only be opened through the EMERGENCY opening button or through the SPYCO/1E\* radio control.
  - b) The door stays closed irrespective of the program selector setting. It can be opened by activating the EMERGENCY opening button, or using the SPYCO/1E\* radio control.
  - c) The door stays closed, but it can be opened by activating any opening control (motion sensors, buttons, etc...).
- This work mode noticeably reduces the battery operating time.

\* optional and associated with the PS-1 digital selector.

- Display mode of the PS-1 digital selector  warning light:
  - a) steadily on when the battery is charged;
  - b) blinking when the battery is almost exhausted.
- Once the mains power supply is restored the system immediately switches to electrical operation and the battery is recharged.  
The  warning light of the PS-1 digital selector goes off.
- When the battery is exhausted or there is no emergency battery, door motion is free and wings may be opened manually if the closing electric lock is not installed.
- If the EBS-2 electric lock is installed and the door is closed wings cannot be moved manually. In this case, to unlock the door, release the electric lock by turning the MANUAL RELEASE knob clockwise by about 45° - 50° (see fig. below, item ② ); under these conditions you can manually open the door.

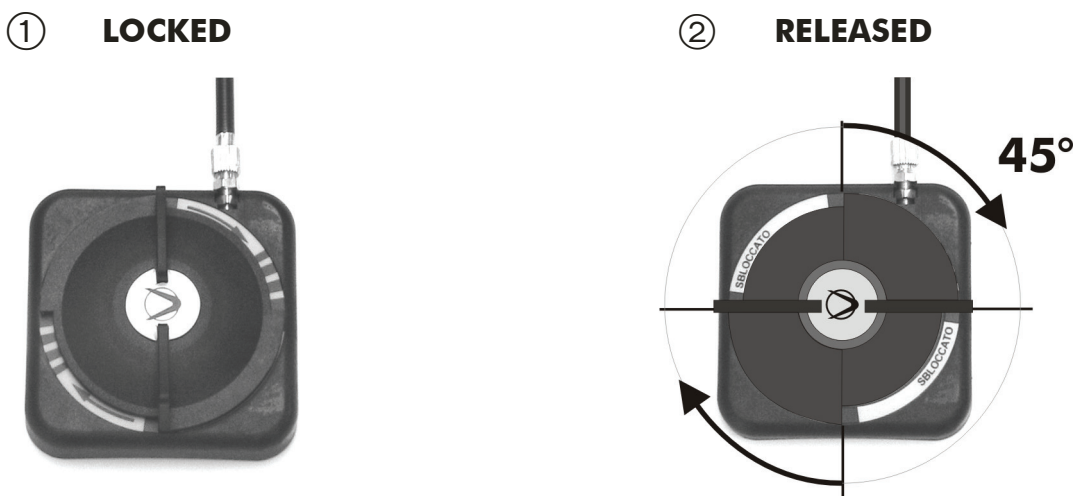

Remember to turn the MANUAL RELEASE knob back to position ① LOCKED to restore the electric lock operation with mains power supply on.

## 7 - OPERATION IN CASE OF POWER SUPPLY FAILURE EVOLUS - EVOLUS-T, HOSPITAL EVH, EVH-E

If the **EV-BAT1** optional module is installed, automatic door operation is guaranteed by an emergency battery.

Depending on the programming of the automation electronic control unit, the door may operate as follows:

- a) Automatically open and stay open if the program selector is not set to Night Lock.
- b) The door stays closed, but it can be opened by activating any opening command (motion sensors, buttons, etc.).

### • POWER SUPPLY LIGHT DISPLAY ON EV-DSEL PROGRAMMER

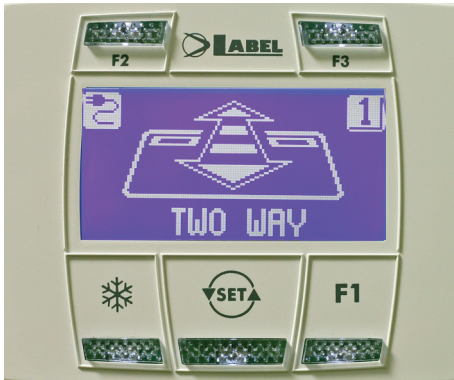

Mains power supply on and connected battery being charged.



Mains power supply off and door operating with charged battery.



Mains power supply off and door operating with almost exhausted battery.

Mains power supply on with inefficient battery.

- When the battery is exhausted or there is no emergency battery, door motion is free and wings may be opened manually if the **EV-EBFSE** closing electric lock is not installed.
- If the **EV-EBFSE** electric lock is installed and the door is closed wings cannot be moved manually. In this case, to unlock the door, release the electric lock by turning the MANUAL RELEASE knob clockwise by about 45° - 50° (see fig. below, item ② ); under these conditions you can manually open the door.

① **LOCKED**



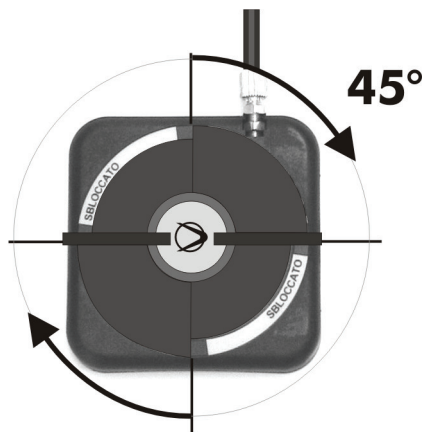

② **RELEASED**





Remember to turn the MANUAL RELEASE knob back to position ① LOCKED to restore the electric lock operation with mains power supply on.



## 8 - NOTIFICATION OF ERRORS AND OPERATION PROBLEMS

<b>BUTTERFLY</b>		
<b>PROBLEM</b>	<b>LIKELY CAUSE</b>	<b>SOLUTION</b>
The door beeps before opening and on the PS-1 selector the  light blinks.	Battery is defective and inefficient. The deviation in the automation behaviour when the problem is detected depends on the programming of the electronic control unit.	If the problem occurs when the mains power supply is off the battery might be getting exhausted. Wait until the power supply is restored. If the problem persists when the mains power supply is on, contact the service centre.
The door opens but it doesn't close and on the PS-1 digital selector the  light blinks.		
The door opens but it doesn't close back.	The motion sensors (radars) or the safety photocell detect the presence of an object or of a person.	Check that the radars or the photocells are not engaged.
The door stops during the stroke and inverts the running direction. During the next operation motion is slower.	The door detects an obstacle along its stroke.	Identify the obstacle and remove it.
	The fixture experiences friction along its stroke.	Properly arrange the fixture; for this operation please contact the service centre.
The electronic control units beeps multiple times and door operation is irregular.	The defect depends on the number and length of the beeps.	Contact the service centre to resolve the problem.
One or more yellow warning lights are on in the PS-1 digital selector.	Each warning light displays the status of the controls and safety devices it refers to (see table in paragraph 4.1)	Check whether there are any objects inside the sensor or photocell detection area. Should the problem persist, please contact the support centre.

<b>EVOLUS, EVOLUS-T, HOSPITAL EVH, EVH-E</b>		
<b>PROBLEM</b>	<b>LIKELY CAUSE</b>	<b>SOLUTION</b>
The door beeps before opening and on the EV-DSEL programmer the  light is on.	Battery is defective and inefficient. The deviation in the automation behaviour when the problem is detected depends on the programming of the electronic control unit.	If the problem occurs when the mains power supply is off the battery might be getting exhausted. Wait for the restoration of the mains power supply. If the problem persists when the mains power supply is on, contact the service centre.
The door opens but it doesn't close and on the EV-DSEL programmer the  light is on.		
The door opens but it doesn't close back.	The motion sensors (radars) or the safety photocell detect the presence of an object or of a person.	Check that the radars or the photocells are not engaged.
The door stops during the stroke and inverts the running direction. During the next operation motion is slower.	The door detects an obstacle along its stroke.	Identify the obstacle and remove it.
	The fixture experiences friction along its stroke.	Properly arrange the fixture; for this operation please contact the service centre.
The electronic control units beeps multiple times and door operation is irregular.	The defect depends on the number and length of the beeps.	Contact the service centre to resolve the problem.

## 9 - MAINTENANCE

---

The maintenance plan must be observed to ensure the life and proper operation of the automatic door. LABEL offers a series of maintenance contracts providing for periodic intervention on the system by specialised technicians.

Offered services are:

- ▶ CHECK AND STABILITY OF FASTENERS;
- ▶ CHECK AND ADJUSTMENT OF THE TRACTION BELT;
- ▶ CLEANING OF THE CARRIAGE SLIDING RAILS AND OF THE GROUND GUIDE;
- ▶ CHECK OF CARRIAGES AND WING ALIGNMENT;
- ▶ PROPER POSITIONING AND FASTENING OF FINAL LEDGES;
- ▶ CHECK OF THE ELECTRIC LOCK AND OF THE MANUAL RELEASE OPERATION;
- ▶ CHECK, ADJUSTMENT (IF REQUIRED) AND CLEANING OF THE MOTION AND PRESENCE SENSORS
- ▶ CHECK OF WING MOTION SPEED AND FORCES;
- ▶ CHECK OF CONNECTIONS AND ELECTRIC WIRING;
- ▶ CHECK OF WING SLIDING SMOOTHNESS ALONG THE WHOLE STROKE;
- ▶ REPLACEMENT OF ANY SYSTEM COMPONENT FOUND TO BE DAMAGED OR WORN WITH GENUINE SPARE PARTS.

Each maintenance operation is recorded into the maintenance register.

The final user must limit himself to cleaning the glass surfaces, the fixture profiles and if necessary the motion and presence sensors, taking care to lock the door while performing these operations.

## 10 - DISPOSAL

---

At the end of its life, this system must be disposed of in accordance with national provisions.

To this purpose we recommend that you contact specialised operators.

---

**LABEL service centre**



## **PART 2: LEAF AUTOMATIC DOOR**

### **TABLE OF CONTENTS:**

1	- INDICATIVE SYSTEM DESCRIPTION	page	20
2	- TECHNICAL DATA		20
3	- AUTOMATIC DOOR OPERATION		21
3.1	- NORMAL DOOR OPERATION		21
3.2	- DOOR OPERATION IN NIGHT LOCK MODE		21
3.3	- SUPPORT OPERATION FOR DISABLED PEOPLE		21
4	- SELECTING THE WORK PROGRAM		22
4.1	- FUNCTION SELECTION SWITCH		22
4.2	- MANUAL SELECTORS SMN - SCN		22
4.3	- DIGITAL SELECTOR SDN1		23
5	- OPERATION IN CASE OF POWER SUPPLY FAILURE		24
6	- NOTIFICATION OF ERRORS AND OPERATION PROBLEMS		25
7	- MAINTENANCE		26
8	- DISPOSAL		26

## 1 - INDICATIVE SYSTEM DESCRIPTION

- ① NEPTIS automation equipment
- ② Motion sensor  
(internal and external radar)
- ③ PROGRAM SELECTOR
- ④ Opening safety photocell
- ⑤ Closing safety photocell
- ⑥ Electric lock
- ⑦ Emergency opening button
- ⑧ Floor stop

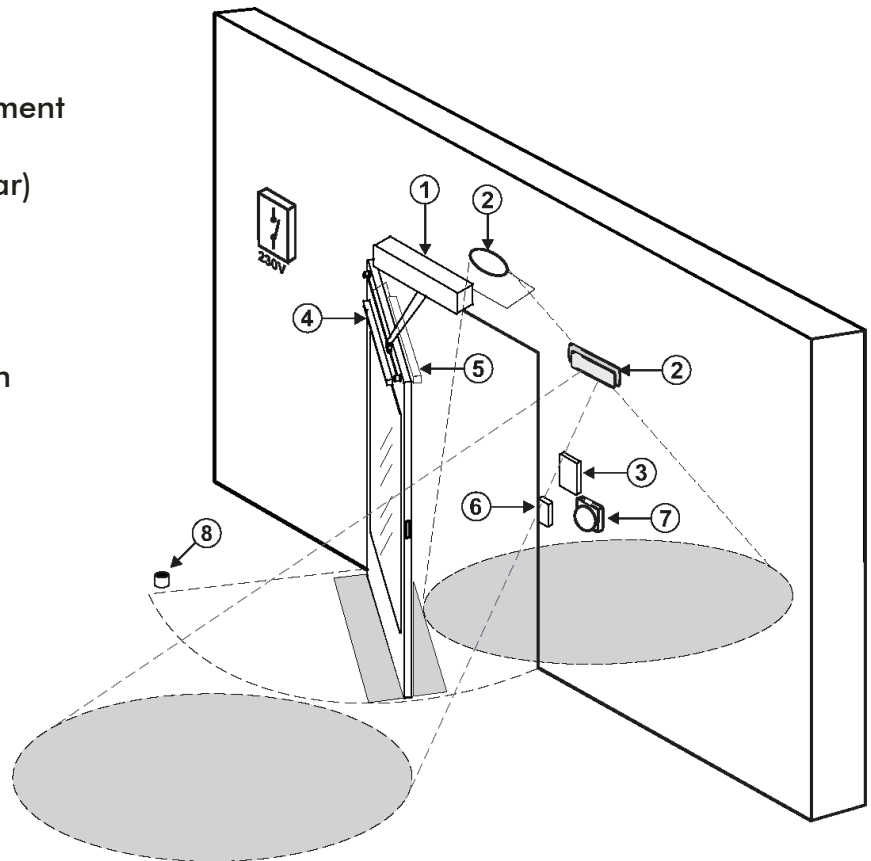

**NOTE:**

The grey part indicates the survey zone of radar and sensors.

## 2 - TECHNICAL DATA

NEPTIS MODEL	
<b>POWER SUPPLY</b>	115/230Vac +/- 10%, 50-60 Hz
<b>POWER</b>	120W
<b>MAXIMUM WEIGHT OF DOOR WING</b>	120 Kg (LE), 250 Kg (SL - SM)
<b>OPERATOR DIMENSIONS</b>	550 x 120 x 110 mm
<b>WORK TYPOLOGY</b>	Intensive use
<b>WORKING TEMPERATURE</b>	- 20° C / + 50° C
<b>PROTECTION DEGREE</b>	IP32
<b>ELECTRIC MOTOR</b>	24Vdc with ENCODER
<b>POWER SUPPLY OF EXTERNAL ACCESSORIES</b>	24Vdc

### 3 - AUTOMATIC DOOR OPERATION

---

---

#### **WARNING!!**

Always contact the assistance technician before commissioning the door, to learn how the automation works.

Switch on the power supply by means of the system switch.

The automation electronic control unit beeps shortly to indicate that the automatic door is powered. The first opening command starts a calibration cycle during which the door opening speed is very low until the end of the stroke, to find the stop point; after the delay time has elapsed, the door closes back at normal speed.

### 3.1 - NORMAL DOOR OPERATION

---

---

- ◆ When something enters the motions sensor (internal and/or external radar) detection area the door opens and stays open until sensors detect the presence, then once the pause delay has elapsed the door closes back.
  - ◆ When the manual door opening button is pressed the door opens and stays open until the command remains active, then once the pause delay has elapsed it closes back.
  - ◆ If the electronic control unit has been properly programmed, you can also open the door with a brief manual push (PUSH and GO function).
  - ◆ When something interrupts the safety photocell rays during closing, the door immediately reopens and stays open as long as the photocell remains engaged.
  - ◆ When the photocell rays are interrupted during the opening, the door stops and doesn't move as long as the photocell is engaged; it will complete the opening cycle only after the photocell is disengaged.
- 
- ◆ If during the opening motion the door bumps against an obstacle, it stops and closes back.
  - ◆ If during the closing motion the door bumps against an obstacle, it stops and opens back.

### 3.2 - DOOR OPERATION IN NIGHT LOCK MODE

---

---

- ◆ The door cannot be opened through the motion sensors (radar).
- ◆ The door may only be opened by activating the emergency opening button.
- ◆ The safety function (photocells and behaviour in case of obstruction) are active and work as described in par. 3.1. for normal operation.

### 3.3 SUPPORT OPERATION FOR DISABLED PEOPLE

---

---

This only applies if the electronic control unit has been programmed and set to the disabled people operating mode.

- ◆ The disabled person may open the door through a special button or sensor.  
The door stays open for a delay time long enough to allow the disabled person to cross the door.  
All the safety functions are on.
- ◆ If the door is opened by manually pushing it (PUSH & GO) it will immediately close; the delay time will be set to the minimum value and the closing safety photocell will be disabled.

## 4 - SELECTING THE WORK PROGRAM

To select the automatic door work program use the selector installed in the system.

The LABEL range includes three models: the SDN1 digital selector and the SMN and SCN manual selectors.

If no external selectors are installed, use the FUNCTION SELECTION switch incorporated into the automation equipment.

### 4.1 - FUNCTION SELECTION SWITCH

On the side panel of the automation equipment there is a 3-position switch allowing to select the door work program.



" " status	=	<b>DAY FUNCTIONS.</b> To open the door by means of all the control inputs
"○" status	=	<b>FREE DOOR.</b> To manually move the door without motor control.
"  " status	=	Operation differs according to the programming of the electronic control unit.
<b>NIGHT LOCK</b>	=	to keep the door closed, allowing its opening only by means of the emergency opening button.
<b>DOOR ALWAYS OPEN</b>	=	to keep the door permanently open.

### 4.2 - MANUAL SELECTORS SMN - SCN

The SMN selector is equipped with a knob allowing to select the work program, while the SCN selector is equipped with a key switch allowing to lock the selection function by removing the key.

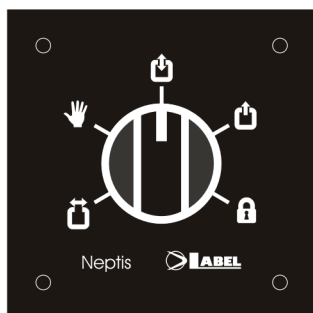

**SMN**

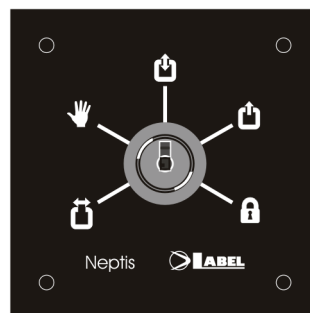

**SCN**

### OPERATING MODE

Turn the knob of the SMN mechanical selector or the key of the SCN selector to select the desired function among the 5 available ones:

	<b>DOOR ALWAYS OPEN</b>	= to keep the door fully open.
	<b>FREE DOOR</b>	= to manually move the door without motor control.
	<b>TWO-WAY TRAFFIC</b>	= to open the door by means of all the control inputs.
	<b>OUTGOING TRAFFIC ONLY</b>	= to exclude the EXTERNAL RADAR input detection.
	<b>NIGHT LOCK</b>	= to keep the door closed, allowing its opening only by means of the EMERGENCY opening button.



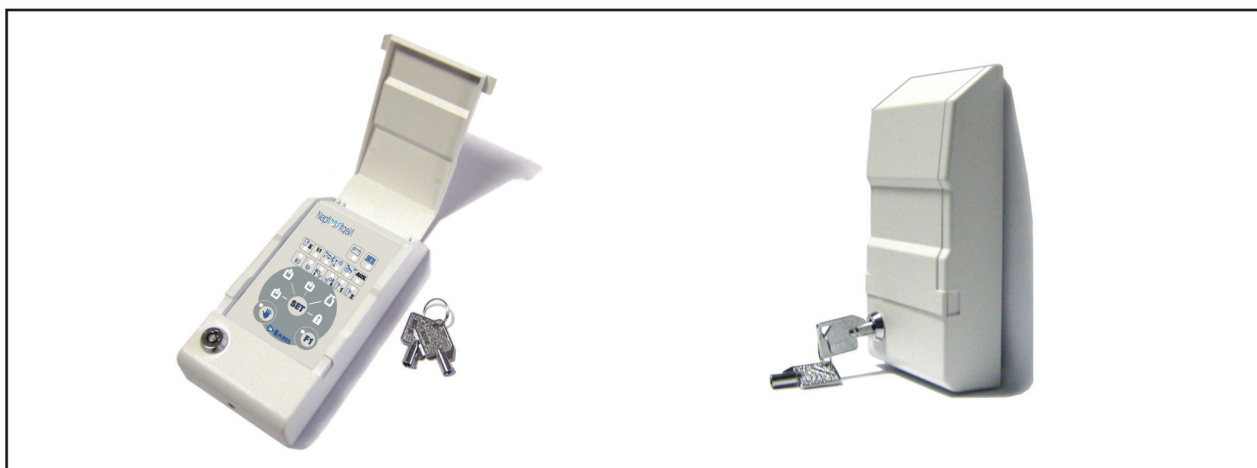

### 4.3 - SDN1 DIGITAL SELECTOR



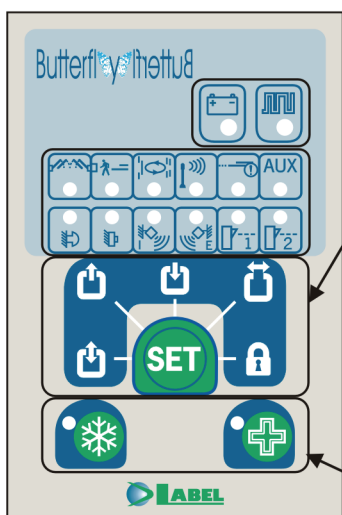

Turn the key switch to FREE FUNCTIONS  using the special supplied key.

By pushing the central button  select the automatic door work mode among the 5 available ones:



-  The door opens by activating any installed opening control.
-  The external radar is deactivated, all other opening controls remain active.
-  The internal radar is deactivated, all other opening controls remain active.
-  The door opens and remains open permanently.
-  The door stays closed and the radars are not enabled. The door can only be opened by using the EMERGENCY opening button, or the SPYCO/1E\* radio control (optional)

Pressing the  button (green led on) will activate the free door function. The motor is not powered and the door can be moved manually.













Pressing the  button (green led on) will disable the step-by-step function\* and enable the automatic closure after the delay time.

\*only if the step-by-step function (a command opens, a second command closes) has been programmed on the electronic control unit.

If you wish to prevent any changes to the set function, turn the key switch to LOCKED FUNCTIONS 

The table below describes the meaning of each warning lamp existing on the front panel of the SDN-1 digital selector; these lamps are associated with the controls and the safety devices installed in the automatic door system.

During normal operation the warning lights are off and only turn yellow when the relevant device is activated.

	EMERGENCY INPUT		PHOTOCELL 3 INPUT
	START INPUT		LIMIT SIGNAL FOR THRUST FORCE
	INTERNAL RADAR INPUT		AUX2 INPUT
	EXTERNAL RADAR INPUT		REMOTE CONTROL SPYCO INPUT
	PHOTOCELL 1 INPUT		SAFETY SENSOR INPUT FOR OPENING
	PHOTOCELL 2 INPUT		AUX1 INPUT

## 5 - OPERATION IN CASE OF POWER SUPPLY FAILURE

### ◆ NEPTIS LE and NEPTIS SL VERSIONS

In case of power supply failure the automation equipment only operates as a door closing device. The door can be opened manually, while the closing cycle is performed through the incorporated closing spring.

### ◆ NEPTIS SM VERSION

In case of power supply failure the door can be opened and closed manually.

If the door is equipped with an electric lock, use the special key to unlock it.



## 6 - NOTIFICATION OF ERRORS AND OPERATION PROBLEMS

PROBLEM	LIKELY CAUSE	SOLUTION
The door opens but it doesn't close back.	The motion sensors (radars) or the closing safety photocell detect the presence of an object or of a person.	Check that the radars or the photocells are not engaged.
The door doesn't complete the opening cycle and stops along the way.	The opening safety photocell detects an obstacle.	Identify the obstacle and remove it.
The door doesn't respond to the opening commands.	The FREE DOOR function can be activated.	Check the setting of the program selector.
The door stops during the stroke and inverts the running direction.	The door detects an obstacle along its stroke.	Identify the obstacle and remove it.
	The fixture experiences friction along its stroke.	Properly arrange the fixture; for this operation please contact the service centre.
The electronic control units beeps multiple times and door operation is irregular.	The defect depends on the number and length of the beeps.	Contact the service centre to resolve the problem.
One or more yellow warning lights are on in the SDN1 digital selector.	Each warning light displays the status of the controls and safety devices it refers to (see table in paragraph 4.3)	Check whether there are any objects inside the sensor or photocell detection area. Should the problem persist, please contact the support centre.

## 7 - MAINTENANCE

---

The maintenance plan must be observed to ensure the life and proper operation of the automatic door. LABEL offers a series of maintenance contracts providing for periodic intervention on the system by specialised technicians.

Offered services are:

- ▶ CHECK AND STABILITY OF FASTENERS;
- ▶ CHECK AND LUBRICATION OF THE CLOSING SPRING;
- ▶ CHECK OF THE ARM ON THE LEAF AND INSPECTION OF THE FIXTURE;
- ▶ CHECK AND LUBRICATION OF THE PIVOTS;
- ▶ CHECK, ADJUSTMENT (IF REQUIRED) AND CLEANING OF THE MOTION AND PRESENCE SENSORS
- ▶ CHECK OF WING MOTION SPEED AND FORCES;
- ▶ CHECK OF CONNECTIONS AND ELECTRIC WIRING;
- ▶ CHECK OF MOTION SMOOTHNESS THROUGHOUT THE LEAF STROKE;
- ▶ REPLACEMENT OF ANY SYSTEM COMPONENT FOUND TO BE DAMAGED OR WORN WITH GENUINE SPARE PARTS.

Each maintenance operation is recorded into the maintenance register.

The final user must limit himself to cleaning the glass surfaces, the fixture profiles and if necessary the motion and presence sensors, taking care to lock the door while performing these operations.

## 8 - DISPOSAL

---

At the end of its life, this system must be disposed of in accordance with national provisions.

To this purpose we recommend that you contact specialised operators.

### **WARNING!**

While uninstalling the operators with incorporated spring lock the spring using the special screw before removing the arm; **the spring pre-tensioning may result in an danger!**

---

LABEL service centre





# PEDESTRIAN AUTOMATIC DOORS



**LABEL S.p.A.**

Via U. Ilariuzzi, 17/A - S.Pancrazio P.se - 43126 - Parma  
Tel. (+39) 0521/6752 - Fax (+39) 0521/675222  
[www.labelsipa.com](http://www.labelsipa.com)



AZIENDA CERTIFICATA  
SISTEMA QUALITA'  
UNI EN ISO 9001:2000