

USER MANUAL

PEDESTRIAN AUTOMATIC SLIDING DOOR for HOSPITALS

GB



EVHT EVOLUS HOSPITAL 16005

Made in Italy by



TRANSLATION OF
ORIGINAL INSTRUCTIONS

RECOMMENDATIONS

THIS INSTRUCTION MANUAL IS INTENDED FOR THE FINAL USER OF A LABEL AUTOMATIC SLIDING DOOR SYSTEM; IT IS UNDERSTOOD THAT INSTALLATION AND TESTING MUST HAVE BEEN CARRIED OUT BY SPECIALISED PERSONNEL.

GENERAL SAFETY WARNINGS



**BEFORE COMMISSIONING THE AUTOMATIC DOOR,
PLEASE CAREFULLY READ THIS MANUAL.**

PROVISIONS

The automatism has been designed to be used exclusively with pedestrian automatic sliding doors. The manufacturer accepts no responsibility for incorrect product usage, as well as for any damages arising from changes to the system made without his prior consent. When operating the system accident prevention regulations must be observed.

REMARKS

Always meet the usage and maintenance conditions provided for by LABEL. Maintenance and repair operations must only be performed by qualified and properly trained personnel.

PROPER BEHAVIOUR

Only use the automatic door if it is in perfect technical conditions. In case of failure or malfunction that might affect safety immediately contact the service centre. Inappropriate use of the system may cause serious injuries and damage.



AUTOMATIC SLIDING DOOR

EVHT
EVOLUS
HOSPITAL
16005

models: **EVHT-S**
EVHT-D

TABLE OF CONTENTS:

1) INDICATIVE SYSTEM DESCRIPTION	page	4
2) TECHNICAL DATA		4
3) AUTOMATIC DOOR OPERATION		5
3.1) NORMAL DOOR OPERATION		5
3.2) DOOR OPERATION IN NIGHT LOCK MODE		5
4) PROGRAM SELECTORS		6
4.1) MECHANICAL KEY SELECTOR EV-MSEL		6
4.2) DIGITAL PROGRAM SELECTOR N-DSEL		7
4.2.1) GENERAL PROGRAMMING MENU		9
4.2.2) PASSWORD		10
4.2.3) LANGUAGE		12
5) OPERATION IN CASE OF POWER SUPPLY FAILURE		13
6) NOTIFICATION OF ERRORS AND OPERATION PROBLEMS		14
7) MAINTENANCE		15
8) DISPOSAL		15

1) INDICATIVE SYSTEM DESCRIPTION

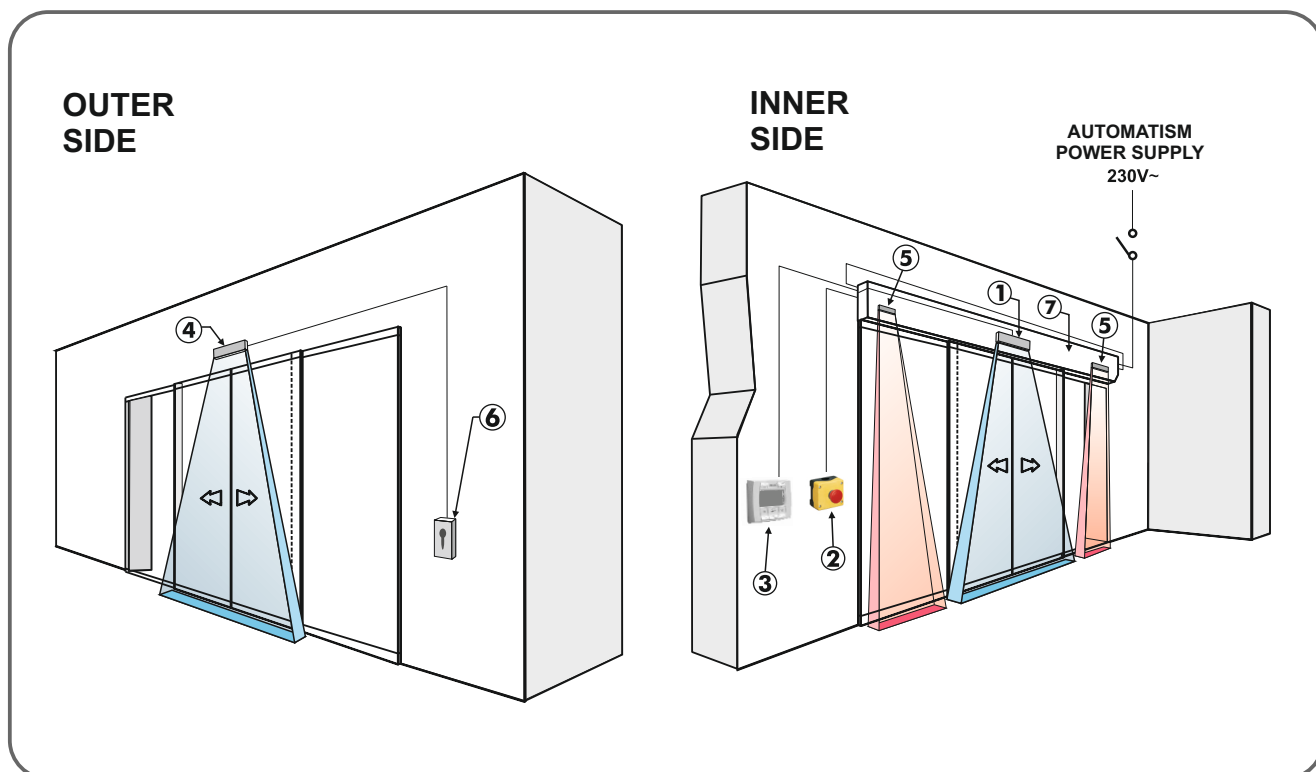

- ① Internal movement and presence sensor for door opening and safety during closing
- ② Emergency opening button
- ③ Digital programmer
- ④ External movement and presence sensor for door opening and safety during closing
- ⑤ Opening safety sensor
- ⑥ Key button
- ⑦ EVHT operator

2) EVHT OPERATOR TECHNICAL DATA

OPERATOR MODEL	EVHT-S (single leaf)	EVHT-D (double leaf)
POWER SUPPLY	230Vac +/-10%, 50-60Hz	
POWER	130W	
FREQUENCY OF USE	continuous	
PAUSE TIME	Max. 20 sec.	
WORKING TEMPERATURE	-15°C +50°C	
DEGREE OF PROTECTION	IP22	
POWER SUPPLY OF EXTERNAL ACCESSORIES	13 Vdc	
EVHT TRANSOM DIMENSIONS (H x D)	120 x150 mm	

3) AUTOMATIC DOOR OPERATION

WARNING!!

Always contact the assistance technician before commissioning the door, to learn how the automation works.

Switch on the power supply by means of the system switch.

The automation electronic control unit beeps shortly to indicate that the automatic door is powered.

The first opening command starts a calibration cycle during which the door opening speed is very low until the end of the stroke, to find the stop point; after the delay time has elapsed, the door closes back at normal speed.

3.1) NORMAL DOOR OPERATION

When something enters the motions sensor (internal and/or external radar) detection area the door opens and stays open until sensors detect the presence, then once the pause delay has elapsed the door closes back.

When the manual door opening button is pressed the door opens and stays open until the command remains active, then once the pause delay has elapsed it closes back.

If the closing safety sensor detects a presence, the door immediately reopens, and stays open as long as the sensor remains engaged.

If the opening safety sensor detects a presence, the door slows down and proceeds very slowly until the opening stroke is completed.

If during the opening motion the door bumps against an obstacle, it stops and closes back.

When it opens again, later, it slows down near the point where it had met the obstacle, to avoid further impact.

If during the closing motion the door bumps against an obstacle, it stops and opens back.

When it closes again, later, it slows down near the point where it had met the obstacle, to avoid further impact.

3.2) DOOR OPERATION IN NIGHT LOCK MODE

The door cannot be opened through the external and internal radars.

The door can only be opened by pressing the OPEN button, or using the Spyco radio-control, if any.

The safety function (sensors and behaviour in case of obstruction) are active and work as described in par. 3.1. for normal operation.

4) PROGRAM SELECTORS





The program selector allows the door user to select the operating mode. Depending on one's preferences, the EV-MSEL mechanical key selector or the N-DSEL digital programmer can be used. Each program selector is described in details below.

4.1) EV-MSEL MECHANICAL KEY SELECTOR



OPERATING MODE

Insert and rotate the key in EV-MSEL selector to select the program desired.

	Open door program The door stops in complete opening position.
	Reduced opening during winter For reducing the opening space
	Bi-directional automatic program The door automatically opens when each opening control activates.
	Single-direction automatic program output only To exclude the incoming detection on external radar input
	Night lock program The door can only be opened through the OPEN input or using the SPYCO remote control, if any.

The key can be taken out of the selector when in any position in order to prevent the work program from undesired changes.

4.2) DIGITAL PROGRAM SELECTOR N-DSEL



By pulse-pressing the  button, choose the automatic door operating mode. Each time a button is pressed, it switches from a work program to the next one.

The operating programs to be selected by  button are described below.



Bi-directional automatic program

The door automatically opens when each opening control activates.



Single-direction automatic program output only

To exclude the incoming detection on external radar input



Single-direction automatic program input only

To exclude the outgoing detection on internal radar input.



Open door program

The door stops in complete opening position.



Night lock program

The door can only be opened through the OPEN input or using the remote control, if any.



Free manual door

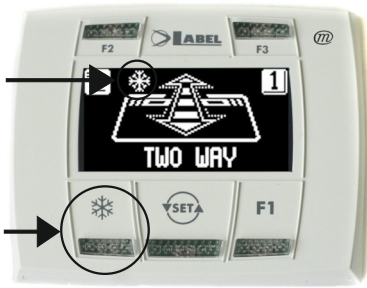

The automatic operation is disabled and door can be manually open.

Operation of other buttons located on N-DSEL program selector panel



REDUCED OPENING DURING WINTER

To reduce the passage opening.

To activate the reduced opening during winter press the  button once; the  symbol on the display indicates that the function is on.

To disable the reduced opening during winter press the  button once more;

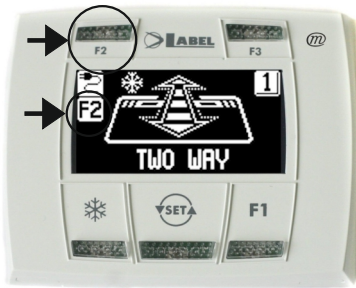

F2

CHEMIST'S OPENING

To open the door by a few centimetres.

(Only if the chemist's function was enabled on the operator during installation).

To enable the chemist's opening press the F2 button once; the F2 symbol appears on the display.

To disable the chemist's opening press the F2 button once more; the F2 symbol goes off on the display.



F1

Door opening command

Pressing the F1 button will open the door.

The F1 may open the door even when the "NIGHT LOCK" work program is selected, if the operator electronic control unit is set accordingly.



F3

It is only used if the N-DSEL digital programmer manages two automatic doors

The N-DSEL digital programmer can independently manage the operation of two EVHT sliding automatic doors.

Pressing the F3 button allows to select the door on which the work program is set;



The number 1 appears on the display when door 1 is selected; the number 2 appears if door 2 is selected.

4.2.1) GENERAL PROGRAMMING MENU

The user can enter the general programming menu when he wishes to select the desired language for the texts that appear on the display, or when he wishes to enable a password to prevent any unauthorised access to the N-DSEL digital programmer.

DIAGRAM 1

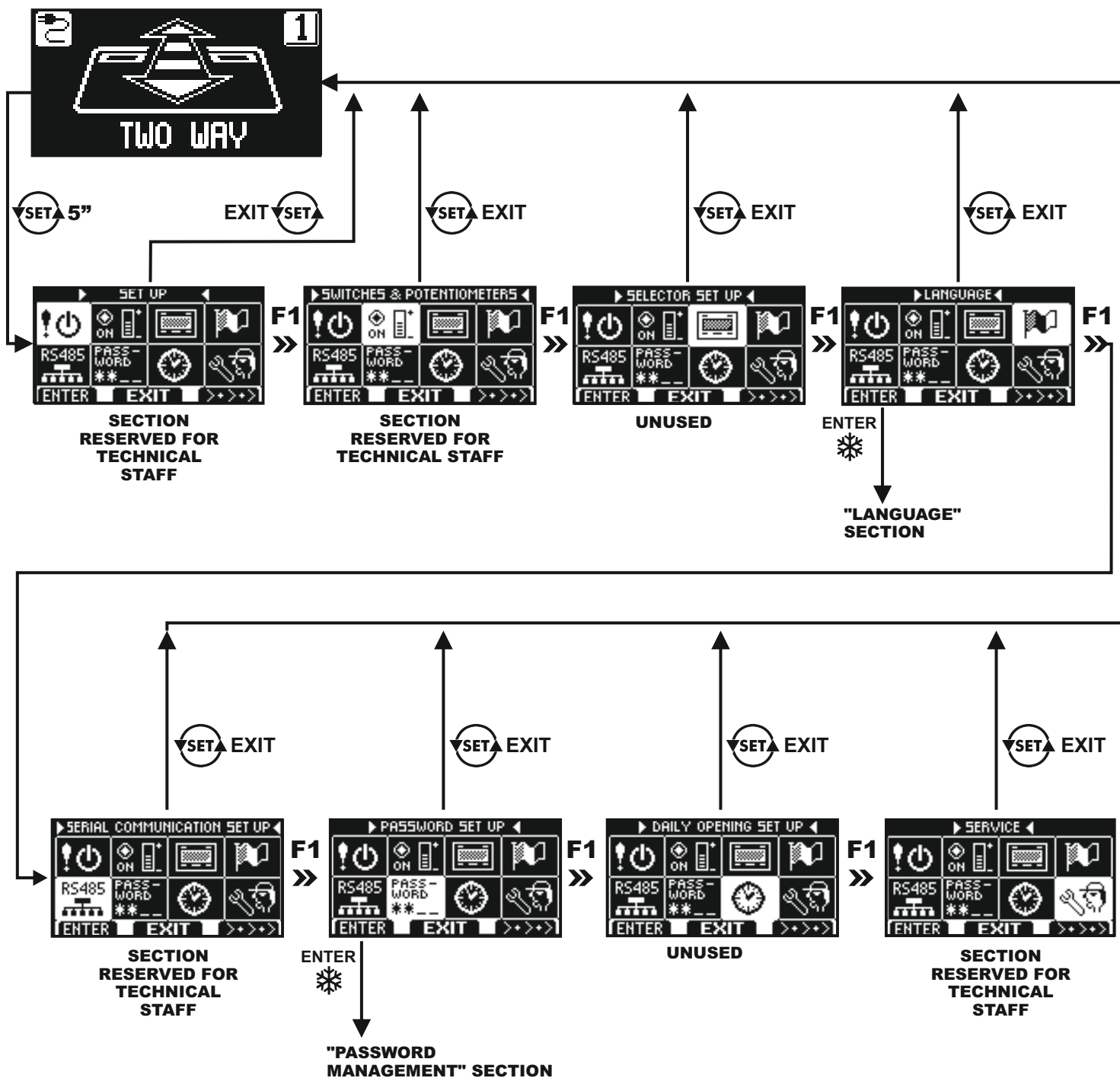

The paragraphs below explain the procedure to be followed to manage the user password and to select the language.

4.2.2) PASSWORD

To prevent the door work program from being modified, a password can be entered that must be input every time the N-DSEL programmer is used.

To enable the password perform the operations listed below:

1. Press the SET button for 5 seconds to access the general programming menu (see Diagram 1 at para. 4.3.1)
2. Press the F1 button five times to switch to the Password Management sub-menu.
3. Press the Enter  button to access the "Password management" section.

PASSWORD MANAGEMENT



This section displays the two passwords available to the final user, the primary password and the service password.

The technical password is only reserved for the technical staff members in charge of installation and maintenance operations.

PRIMARY PASSWORD (for the system's owner-user)

It is a 5-character password used by the user to prevent unauthorized persons from having access to N-DSEL programmer and change the work program.

Using a primary password is optional and must be enabled by system's owner.

Default preset primary password is "A-A-A-A-A".

WARNING!

When enabling the password, be careful not to forget the access combination.

SERVICE PASSWORD (for user)

It is a 5-character password that the system's owner may divulge to persons to be authorized to use N-DSEL programmer.

The service password only allows changing the automatic door work program.

Default preset service password is "A-A-A-A-A".

To change the service password, it is necessary to have access by primary password.

Use the  button to move the selection arrow downward, F2 button to move back upward.

HOW TO CHANGE THE PRIMARY PASSWORD

- Select "PRIMARY PASSWORD"
- Press OK (F1) button.



- Type the default preset primary password "A-A-A-A-A" by pressing 5 times on A button. (If the primary password is not the default password as it had already been changed before, type the currently-used primary password).



- Type the new primary password, selecting a combination of 5 characters from the letters A-B-C-D.



- It is required to repeat the new password, so type the previous combination again.



- If the typed password is correct the "PASSWORD OK" message appears on the display for one second, then the system switches back to the PASSWORD MANAGEMENT section; press the EXIT (Y/SET) button to return to the general programming menu
- If the typed password doesn't match the previous one, the PASSWORD ERROR message appears on the display; the system will switch back to the PASSWORD MANAGEMENT section and the user will have to repeat the procedure.

HOW TO CHANGE THE SERVICE PASSWORD

- Select "SERVICE PASSWORD".
- Press OK (F1) button.



- Type the primary password



- Type the new service password, selecting a combination of 5 characters from the letters A-B-C-D.



- It is required to repeat the new password, so type the previous combination again.

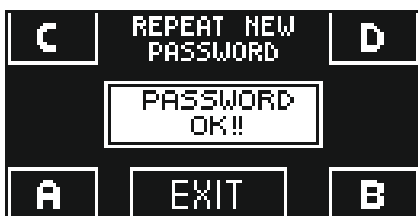

- If the password typed is correct, "PASSWORD OK" is shown on display for one second and the system returns to the PASSWORD MANAGEMENT section.

Press the EXIT (Y/SET) button to return to general programming menu.

If the typed password doesn't match the previous one, the PASSWORD ERROR message appears on the display; the system will switch back to the PASSWORD MANAGEMENT section and the user will have to repeat the procedure.

ENABLING USER PASSWORD USAGE (primary and service)

- Select "PASSWORD ON / OFF"
- Press OK (F1) button.

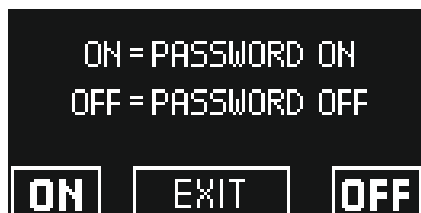

- Press the ON button to enable the usage of user passwords and return to the PASSWORD MANAGEMENT menu. To return to the work program view press the EXIT button twice.
- From this moment on, whenever the user wants to access to N-DSEL digital programmer to change the automatic door work program, the primary or service password must be typed.

When the user decides to enable the password usage, it is recommended to change the combination of both primary and service password.

DISABLING USER PASSWORD USAGE

- From the PASSWORD MANAGEMENT section, select "PASSWORD ON / OFF"
- Press OK (F1) button.



- Type the primary password

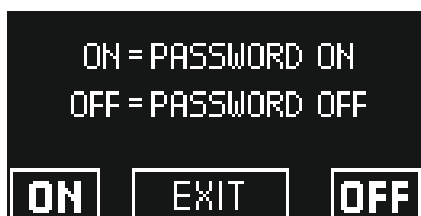

- Press the OFF button (F1) to disable user password usage. To return to the general programming menu press the EXIT button twice. From this moment on, the access to N-DSEL digital programmer like program selector is free.

4.2.3) LANGUAGE

To select the language perform the operations listed below:

1. Press the button for 5 seconds to enter the general programming menu. (see Diagram 1 in the previous paragraph)
2. Press the F1 three times to switch to the Language sub-menu.
3. Press the Enter button to access the "Language" section.

- Use the F2 and buttons to move arrow to the desired language.
- Press the EXIT button to return to general programming menu.
- Press the EXIT button again to return to the main view of the automatic door work program.



5 - OPERATION IN CASE OF POWER SUPPLY FAILURE

If the battery module is installed in the operator, automatic door operation is guaranteed by an emergency battery.

Depending on the programming of the automation electronic control unit, the door may operate as follows:

- a) Automatically open and stay open if the program selector is not set to Night Lock.
- b) The door stays closed, but it can be opened by activating any opening command (motion radars, buttons, etc.).

• POWER SUPPLY LIGHT DISPLAY on N-DSEL PROGRAMMER

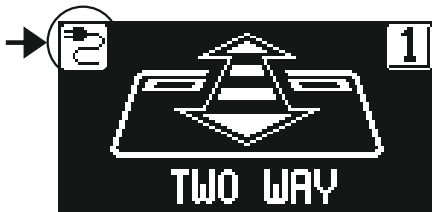

Mains power supply on and connected battery being charged.

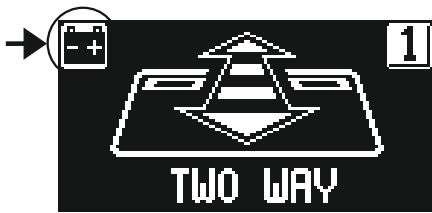

Mains power supply off and door operating with charged battery.

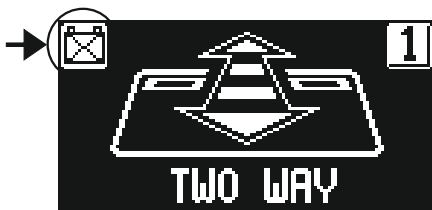

- Mains power supply off and door operating with almost exhausted battery.
- Mains power supply on with inefficient battery.

- When the battery is exhausted or there is no emergency battery, door motion is free and wings may be opened manually if the EV-EBFSE closing electric lock is not installed.
- If the EV-EBFSE electric lock is installed and the door is closed wings cannot be moved manually. In this case, to unlock the door, release the electric lock by turning the MANUAL RELEASE knob clockwise by about 45° - 50° (see fig. below, item ②); under these conditions you can manually open the door.

① LOCKED

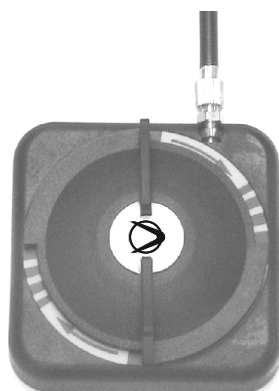

② RELEASED

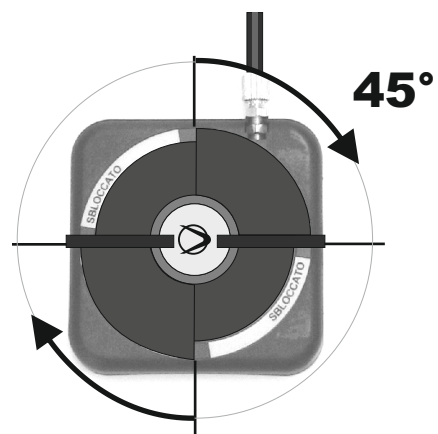

Remember to turn the MANUAL RELEASE knob back to position ① LOCKED to restore the electric lock operation with mains power supply on.

PROBLEM	LIKELY CAUSE	SOLUTION
The door opens but it doesn't close back.	The motion radars or the closing safety sensor detect the presence of an object or of a person.	Check that the radars or the sensors are not engaged.
The door opens very slowly.	The opening safety sensor detects an obstacle.	Identify the obstacle and remove it.
The door doesn't respond to the opening commands.	The MANUAL FREE DOOR function can be activated.	Check the setting of the program selector.
The door stops during the stroke and inverts the running direction.	The door detects an obstacle along its stroke.	Identify the obstacle and remove it.
	The fixture experiences friction along its stroke.	Properly arrange the fixture; for this operation please contact the service centre.
The electronic control units beeps multiple times and door operation is irregular.	The defect depends on the number and length of the beeps.	Contact the service centre to resolve the problem.
The  symbol appears on the display	The system has detected a machine operation error.	Contact the service centre to resolve the problem.

Should any malfunction occur, the Customer must contact the Support Centre and use the door manually, without powering it.

7 - MAINTENANCE

The maintenance plan must be observed to ensure the life and safe operation of the automatic door. We recommend that you sign a maintenance contract providing for periodic intervention on the system by specialised technicians.

If the user has the N-DSEL program selector, he will be warned that the maintenance interval has expired when the message "PROGRAMMED MAINTENANCE" message is shown on the display.

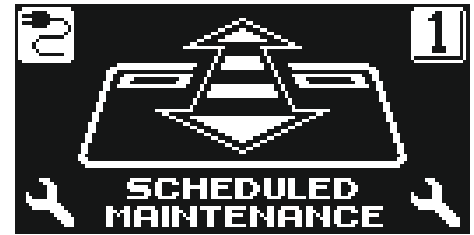

Each maintenance operation is recorded into the maintenance register. The final user must limit himself to cleaning the glass surfaces, the fixture profiles and if necessary the motion and presence sensors, taking care to lock the door while performing these operations.

8 - DISPOSAL

At the end of its life, this system must be disposed of in accordance with national provisions. To this purpose we recommend that you contact specialised operators.

LABEL service centre



EVOLUS

Made in Italy
by



Via Ilariuzzi, 17/A - S. Pancrazio P.se - 43126 PARMA - ITALIA
Tel. (+39) 05 21/ 67 52 - Fax (+39) 05 21/ 67 52 22
infocom@labelspa.it - www.labelspa.com



AZIENDA CERTIFICATA
SISTEMA QUALITA'
UNI EN ISO 9001:2000