

USER MANUAL



EN

NEPTIS PLUS



NB-SLT
NB-SLTB

NB-LET
NB-LETB

NB-SMT
NB-SMTB

NB-SMP

NB-SLP

Pedestrian automatic swing door



English
TRANSLATION OF THE ORIGINAL INSTRUCTIONS

NEPTIS PLUS - Manuale d'Uso - EN - Rel.1.0 - 04/2021 - CD0450EN

RECOMMENDATIONS

THIS INSTRUCTION MANUAL IS INTENDED FOR THE FINAL USER OF A LABEL AUTOMATIC SWING DOOR SYSTEM; IT IS UNDERSTOOD THAT INSTALLATION AND TESTING MUST HAVE BEEN CARRIED OUT BY SPECIALISED PERSONNEL.

GENERAL SAFETY WARNINGS



CAREFULLY READ THIS MANUAL BEFORE COMMISSIONING THE AUTOMATIC DOOR.

PROVISIONS

The automation has been designed to be used exclusively with pedestrian automatic swing doors.

The manufacturer shall not be liable for incorrect product usage, as well as for any damages arising from changes to the system made without its prior consent.

When operating the system, accident prevention regulations must be observed.

The equipment can be used by children of at least 8 years of age and by people with reduced physical, sensory or mental skills, or by inexperienced people, provided they are supervised, or after the same have received instructions relating to the safe use of the equipment and to the understanding of the relevant hazards.

Children should not play with the equipment.

Cleaning and maintenance intended to be performed by the user must not be carried out by children without supervision.

Do not let children stay or play within the operating range of the door.

REMARKS

Always respect the usage and maintenance conditions provided for by LABEL.

Maintenance and repair operations must only be performed by qualified and properly trained personnel.

PROPER BEHAVIOUR

Only use the automatic door if it is in perfect technical conditions.

In case of failure or malfunction that might affect safety, immediately contact the service centre.

Inappropriate use of the system may cause serious injuries and damage.

CONTENTS:

1) INDICATIVE DESCRIPTION OF THE SYSTEM	4
2) TECHNICAL DATA	4
3) AUTOMATIC DOOR OPERATION	5
3.1) NORMAL DOOR OPERATION	5
3.2) DOOR OPERATION IN NIGHT LOCK MODE	5
3.3) COURTESY MODE FOR DISABLED	5
4) PROGRAM SELECTORS	6
4.1) MANUAL PROGRAM SELECTOR	6
4.2) MECHANICAL KEY SELECTOR EV-MSEL	6
4.3) DIGITAL PROGRAM SELECTOR ET-DSEL	7
4.4) DIGITAL PROGRAM SELECTOR T-NFC	8
4.5) SELECTOR ET-DSEL GENERAL PROGRAMMING MENU	9
4.6) ET-DSEL SELECTOR USER PASSWORD MANAGEMENT	10
4.7) T-NFC SELECTOR USER PASSWORD MANAGEMENT	12
4.8) LANGUAGE	13
5) OPERATION IN CASE OF POWER SUPPLY FAILURE	13
6) NOTIFICATION OF ERRORS AND OPERATIONAL ISSUES	14
7) MAINTENANCE	15
8) DISPOSAL	15

1) INDICATIVE DESCRIPTION OF THE SYSTEM

NOTE:
The grey part indicates the monitoring zone of radars and sensors.

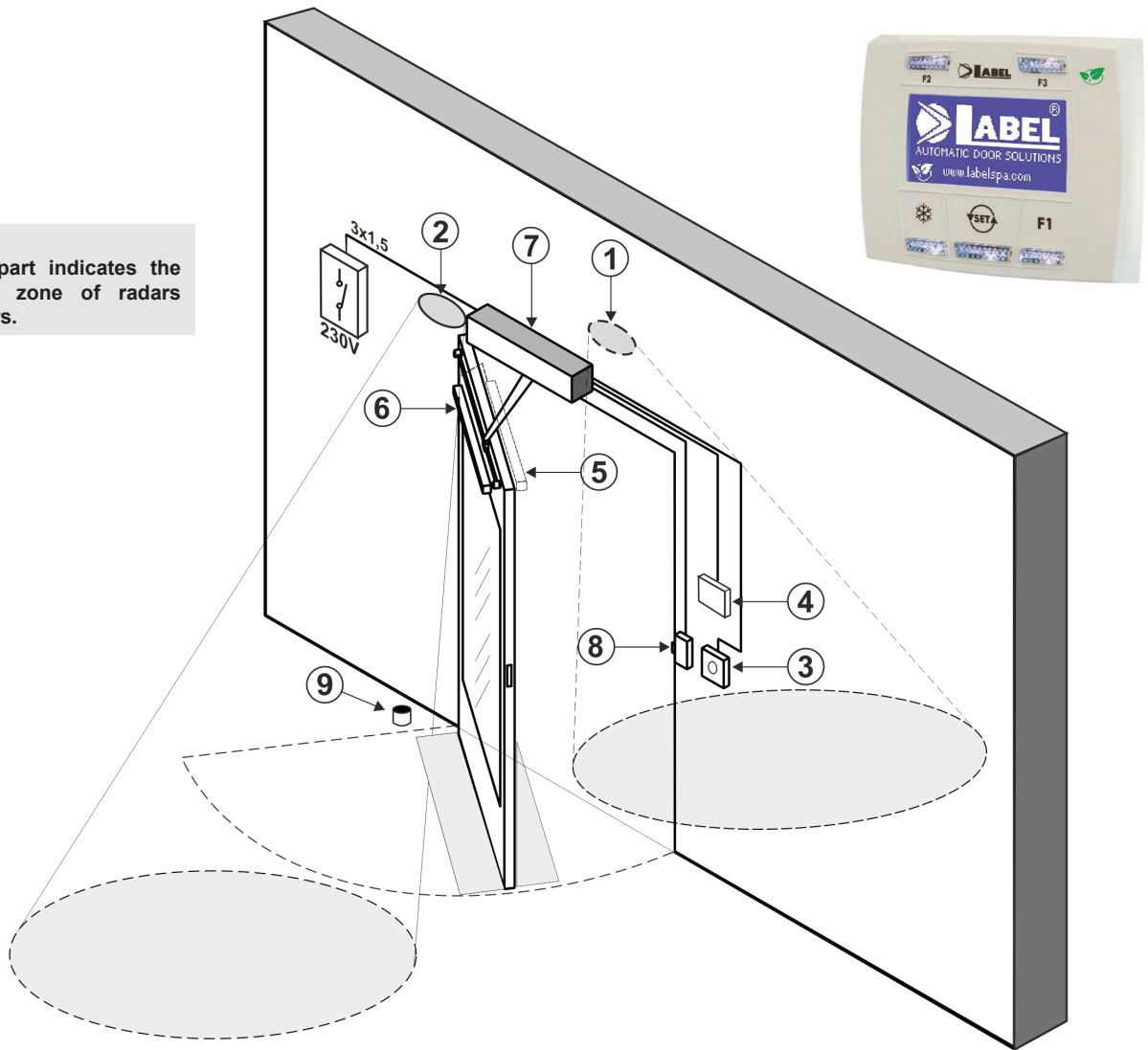

- | | |
|---|------------------------|
| ① | EXTERNAL RADAR |
| ② | INTERNAL RADAR |
| ③ | OPENING COMMAND |
| ④ | PROGRAM SELECTOR |
| ⑤ | CLOSING SAFETY SENSOR |
| ⑥ | OPENING SAFETY SENSOR |
| ⑦ | AUTOMATION NEPTIS PLUS |
| ⑧ | ELECTRIC LOCK |
| ⑨ | FLOOR STOP |

2) TECHNICAL DATA

AUTOMATION MODEL	NB-LET, NB-LETB, NB-SLT, NB-SLTB, NB-SMT, NB-SMTB, NB-SMP, NB-SLP
POWER SUPPLY	115/230V~, +/-10%, 50-60Hz
POWER	100W
LEAF MAX. WEIGHT	120 Kg (NB-LET), 250 Kg (NB-SLT, NB-SMT), 300 Kg (NB-SLT, NB-SMT)
DIMENSIONS NB-LET, NB-SLT, NB-SMT (L x H x D)	550 x 110 x 120 mm
DIMENSIONS NB-LETB, NB-SLTB, NB-SMTB, NB-SMP, NB-SLP (L x H x D)	730 x 110 x 120 mm
FREQUENCY OF USE	continuous
OPERATING TEMPERATURE	-15° C +50°C
PROTECTION CLASS	IP31
STAND-BY CONSUMPTION	5 W
SOUND PRESSURE EMISSION	LpA ≤ 70dB (A)

3) AUTOMATIC DOOR OPERATION

WARNING!!

Always contact the service technician before putting into service the door, to learn how the automation works.

Switch on the power supply by means of the system switch.

The automation electronic control unit beeps shortly to indicate that the automatic door is powered.

The first opening command starts a calibration cycle during which the door opening speed is very low until the end of the motion, to find the stop point; after the delay time has elapsed, the door closes back at normal speed.

3.1) NORMAL DOOR OPERATION

- When something enters the motion sensors (internal and/or external radar) detection area, the door opens and stays open until the sensors detect the presence, then once the pause delay has elapsed the door closes back.
- When the manual door opening button is pressed, the door opens and stays open until the command remains active, then once the pause delay has elapsed it closes back.
- If the electronic control unit has been set with the PUSH & GO function you can open the door also with a short manual push.
- If the closing safety sensor detects a presence, the door immediately reopens, and stays open as long as the sensor remains engaged.
- If the opening safety sensor detects a presence, the door stops and remains stationary for the entire period in which the sensor is engaged; it will complete the opening cycle only after the sensor is released.
- If during the opening motion the door collides against an obstacle, it stops and closes back.
- If, during the closing motion, the door collides against an obstacle, it stops and opens back.

3.2) DOOR OPERATION IN NIGHT LOCK MODE

- The door cannot be opened by means of the external and internal radars.
- The door can only be opened by pressing the OPEN button, or using the Spyco radio-control, if any.
- The safety functions (sensors and behaviour in case of obstruction) are active and operate as described in par. 3.1. related to normal operation.

3.3) COURTESY MODE FOR DISABLED

This only applies if the electronic control unit has been programmed and set to the disabled people operating mode.

- The disabled person may open the door through a special button or motion sensor.
The door stays open for a delay time long enough to allow the disabled person to cross the door.
- All the safety functions are on.

4) PROGRAM SELECTORS

The program selector allows the user to select the operating mode of the door. Depending on the preference, it is possible to use the manual selector incorporated in the side cap of the automation NEPTIS PLUS, the mechanical key selector EV-MSEL, or the digital selector ET-DSEL or T-NFC. Each program selector is fully described below.

4.1) MANUAL PROGRAM SELECTOR

The 3-position manual program selector is the basic solution provided on the automation.

- Position I = Automatic bidirectional program
The door automatically opens after an opening command.
- Position 0 = Manual free door
Automatic operation is disabled and the door can be opened manually.
- Position II = a) Night lock program
The door can only be opened through the OPEN input or using the remote control.
- It can operate in two different ways depending on the setting on the electronic control unit of the automation: b) Open door program
The door remains motionless in the position of complete opening.

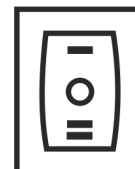

4.2) MECHANICAL KEY SELECTOR EV-MSEL



OPERATING MODE

Insert and turn the key of the selector EV-MSEL to select the desired program.

	Open door program The door remains motionless in the position of complete opening.
	Manual free door Automatic operation is disabled and the door can be opened manually.
	Automatic bidirectional program The door automatically opens after an opening command.
	Automatic unidirectional exit only program To disable entry detection on external Radar input.
	Night lock program The door can only be opened through the OPEN input or using the SPYCO remote control, if any.

The key can be taken out of the selector when in any position in order to prevent undesired changes to the work program.

4.3) DIGITAL PROGRAM SELECTOR ET-DSEL



Pressing briefly the button **YSETA**, select the automatic door operating mode. Whenever the button is pressed, you switch from a work program to the next.

The work programs which can be selected using the button **YSETA** are described below



Automatic bidirectional program

The door automatically opens after an opening command.



Automatic unidirectional exit only program

To disable entry detection on external Radar input.



Automatic unidirectional entry only program

To disable exit detection on internal Radar input.



Open door program

The door remains motionless in the position of complete opening.



Night lock program

The door can only be opened through the OPEN input or using the remote control, if any.



Manual free door

Automatic operation is disabled and the door can be opened manually.

Operation of other buttons located on the panel of the program selector ET-DSEL

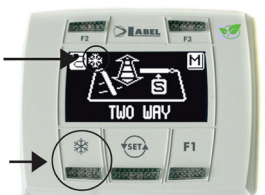

Partial opening, used only in a double leaf door automation

To activate partial opening, press briefly the button ;

the symbol on the display indicates that the function is on.

In a dual leaf door, only the first leaf (Master) opens if the opening command is given from the internal or external radar inputs.

Partial opening only operates in bi-directional, unidirectional, and open door automatic programs.

To disable partial opening, press again briefly the button .

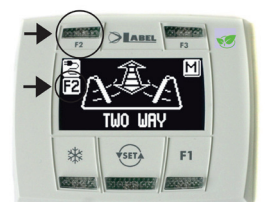

F2

It can have two distinct functions, depending on the setting of the automation.

a) Disables spring actuated door reclosing after a manual opening. (for mod. NB-SMT, NB-SMTB, NB-SMP only).

With F2 off, the door closes, with F2 on, the door remains stationary after a manual opening.

b) Disables step by step operation

(If enabled in the settings on the electronic control unit of the automation)

Press briefly the button F2 to disable step by step operation and enable the automatic closure of the door. The symbol F2 lights up on the display.

To enable step by step operation, press again the button F2, the symbol F2 turns off on the display.



F1

Door opening command

Pressing the F1 button will open the door.

The button F1 may open the door even when the "NIGHT LOCK" work program is selected, if the automation electronic control unit is set accordingly.

4.4) DIGITAL PROGRAM SELECTOR T-NFC

DAILY USE

The selector T-NFC enables to select for daily use 6 different types of programs:



AUTO:

The door opens and closes automatically in both flow directions with all sensors active.



ENTRY:

The door opens and closes automatically only in entry direction:
The sensor connected on the Internal Radar input is disabled.

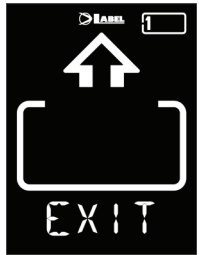

EXIT:

The door opens and closes automatically only in exit direction:
The sensor connected on the External Radar input is disabled.



OPEN:

The door opens and remains open until you change the work program.



LOCK:

CLOSED DOOR

The door can be opened automatically only by means of some specific inputs (Open, RX).

Each time the door closes, the electric lock (if any) activates.



MANUAL:

The door can be moved manually and does not react to any input that is activated.

Use this work program if you want, for instance, to clean the panes, being sure that the door cannot move if you accidentally activate the opening sensors or any other activation command.

To change a work program, press the SET button once to exit the "Screen Saver" function and thus activate the selector (the screen will increase its brightness), now press SET again several times until you position on the desired work program.

If you have activated the program lock with the SLIDE function, to exit the "Screen Saver" slide your finger from left to right on the buttons A* - SET - B to activate the selector.



Warning!

If no button is pressed for approximately 20 seconds, the selector automatically switches to "Screen Saver" mode and reduces the brightness of the display.



In addition to the work program, it is possible to select at any time a partial opening with respect to the standard one (used in double leaf doors to open only the main leaf).

To do this, press the button A, the corresponding symbol  appears on the display and the flow direction icons (if active) will become thinner.

Press again button A to return to complete opening.

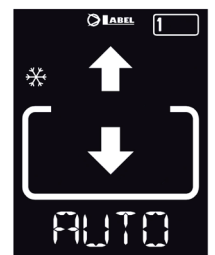
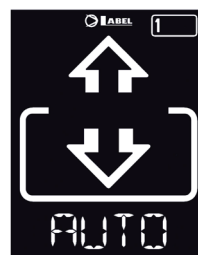

DOOR OPENING FROM T-NFC

The button B, if pressed, generates a door opening command, closure will take place automatically as for the other sensors. This button is able to open the door even in "LOCK" work program, if the function is active.

4.5) SELECTOR ET-DSEL GENERAL PROGRAMMING MENU

The user can enter the general programming menu when he wishes to select the desired language for the texts that appear on the display, or when he wishes to enable a password to prevent any unauthorised access to the digital selector ET-DSEL.

DIAGRAM 1

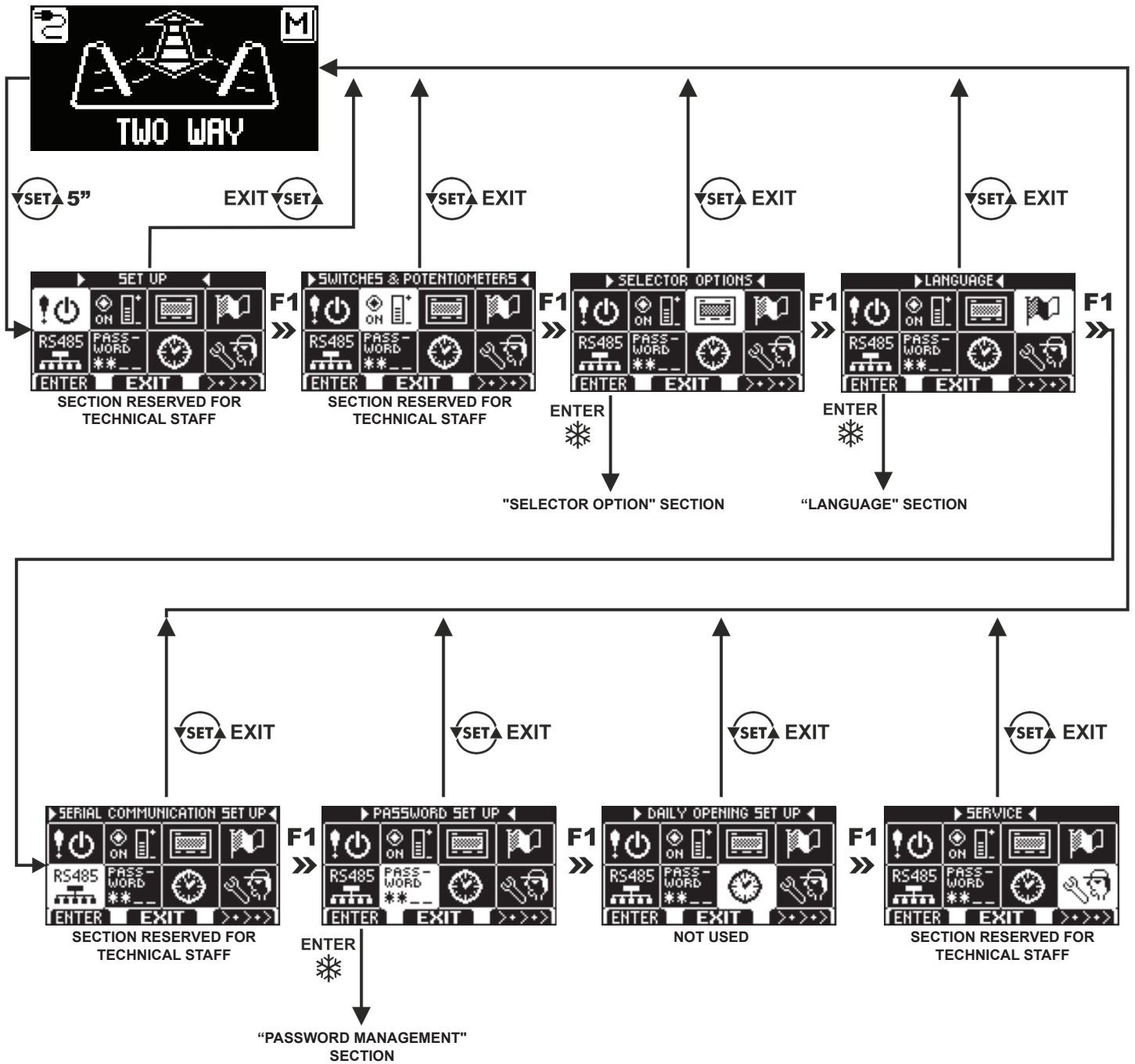

The paragraphs below explain the procedure to be followed to manage the user password and to select the language.

4.6) ET-DSEL SELECTOR USER PASSWORD MANAGEMENT

To prevent the door work program from being modified, it is possible to set a password that must be entered every time the selector ET-DSEL is used.

To enable the password, perform the operations listed below:

1. Press the SET button for 5 seconds to access the general programming menu (see Diagram 1)
2. Press the button F1 five times to go to the Password Management sub-menu.
3. Press the Enter button  to access the section "Password management".

PASSWORD MANAGEMENT



This section displays the two passwords available to the final user, the primary password and the service password.

The technical password is only reserved for the technical staff in charge of installation and maintenance operations.

PRIMARY PASSWORD (for the system owner-user)

It is a 5-character password used by the user to prevent unauthorized persons from having access to the selector ET-DSEL and change the work program.

Using a primary password is optional and must be enabled by the system owner.

The default technical password is "A-A-A-A-A".



WARNING!

When enabling the password, be very careful not to forget the access combination.

SERVICE PASSWORD (for user)

It is a 5-character password that the system's owner may provide to persons authorized to use the selector ET-DSEL.

With the service password, it is only possible to change the work program of the automatic door.

The default service password is "A-A-A-A-A".

To change the service password, it is necessary to log in using the primary password.

Use the button  to move the selection arrow downward, the F2 button to move back upward.

HOW TO CHANGE THE PRIMARY PASSWORD

- Select "PRIMARY PASSWORD"
- Press OK (F1).



- Enter the default primary password "A-A-A-A-A" pressing 5 times the button A. (If the primary password is not the default password, since it had already been changed before, enter the currently-used primary password).



- Enter the new primary password, selecting a combination of 5 characters from the letters A-B-C-D.



- You are prompted to repeat the new password, so enter again the previous combination.



- If the password entered is correct, the message "PASSWORD OK" is displayed for one second, then the system returns to the PASSWORD MANAGEMENT section. Press the EXIT  button to return to the general programming menu
- If the password you entered does not match the previous one, the display shows PASSWORD ERROR, the system returns to the section PASSWORD MANAGEMENT and it is necessary to perform again the procedure.

HOW TO CHANGE THE SERVICE PASSWORD

- Select "SERVICE PASSWORD"
- Press OK (F1).

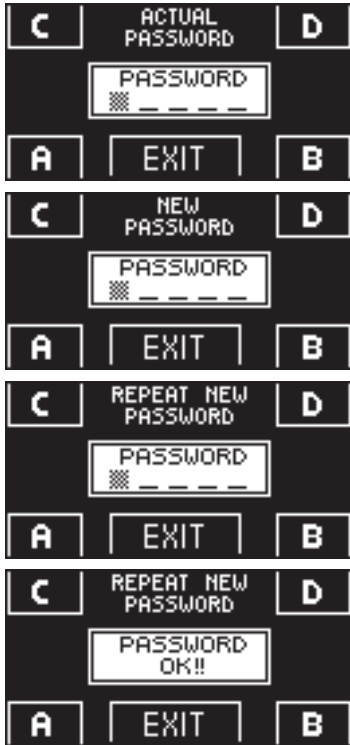

- Enter the primary password
- Enter the new service password, selecting a combination of 5 characters from the letters A-B-C-D.
- You are prompted to repeat the new password, so enter again the previous combination.
- If the password entered is correct, "PASSWORD OK" is displayed for one second and the system returns to the PASSWORD MANAGEMENT section.

Press the EXIT  button to return to the general programming menu.

If the password you entered does not match the previous one, the display shows PASSWORD ERROR, the system returns to the section PASSWORD MANAGEMENT, and it is necessary to perform again the procedure.

ENABLING USER PASSWORD USAGE (primary and service password)

- Select "PASSWORD ON / OFF"
- Press OK (F1).
- Enter the primary password



- Press the ON  button to enable the usage of user passwords and return to the menu PASSWORD MANAGEMENT.

To return to the work program view, press the EXIT  button twice.

From this moment on, whenever the user wants to access the digital selector ET-DSEL to change the automatic door work program, the primary or service password must be entered.



When the user decides to enable password usage, it is recommended to change the combination of both primary and service password.

DISABLING USER PASSWORD USAGE

- From the PASSWORD MANAGEMENT section, select "PASSWORD ON / OFF"
- Press the button OK (F1)



- Enter the primary password



- Press the OFF button (F1) to disable user password usage. To return to the general programming menu, press the EXIT  button twice. Access to the digital selector ET-DSEL as program selector now is free.

4.7) T-NFC SELECTOR USER PASSWORD MANAGEMENT

The selector T-NFC enables to prevent the work program change by means of a password.
This function is useful if you want to prevent unauthorized persons from setting the work program of the door.
To do this, you need to enable the user password with the following steps:
Press and hold button D for approximately 2 seconds.
The display will show the message "CODE>....."



Enter the current password (default AAAAA) with the buttons A-B-C-D (5 digits)
Now we are inside the user password area, from where you can access 3 different selections:

- PASSWORD 1:** To change the code of the main password
- PASSWORD 2:** To change the code of the service password
- PASSWORD ON/OFF:** To enable or disable the primary and the service password.

Repeatedly pressing the button A, you can move in sequence to all 3 selections.



Warning!

The main password (1) is the only one that enables to enter the user password area and should therefore be known only by the owner of the store/organization in which the door is installed.

The service password (2) instead is used for employees or third parties that can use it to change the work programs of the door, but cannot in any way change or disable both passwords.

To change the password 1, press the button B after selecting PASSWORD 1. The display will show:



Enter the new password.
The next screen will be:



Enter again the new password.

Repeat the same sequence to change password 2.

Finally, in order to enable the password, select PASSWORD ON/OFF by means of button B, and select ON by means of button D (ON).





Once you have enabled the password, press the button SET to exit this area and return to the main screen.

Now, after the selector is in "Screen Saver" mode, press the button SET, every time you will be prompted by the selector to enter the password to access program change.

To disable the user password, select PASSWORD ON/OFF by means of button B, and select OFF by means of button B (OFF).

4.8) LANGUAGE

To select the language on the selector ET-DSEL, perform the operations listed below:

1. Press the button  for 5 seconds to enter the general programming menu. (see Diagram 1 in the previous paragraph)
 2. Press the button **F1** three times to go to the Language sub-menu.
 3. Press the Enter button  to access the section "Language".
- Use the buttons **F2** and  to move the arrow in correspondence with the desired language.
 - Press the EXIT button  to return to general programming menu.
 - Press the EXIT button  again to return to the main view of the automatic door work program.







5) OPERATION IN CASE OF POWER SUPPLY FAILURE

In case of power supply failure the door can be opened and closed manually.
If the door is equipped with an electric lock, use the special key to unlock it.

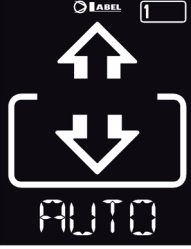
If the automation is equipped with battery, depending on the programming of the automation electronic control unit, the door may operate as follows:

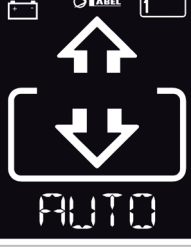
- a) The door can be opened by activating any opening command (motion radars, buttons, etc.).
- b) The door opens automatically and stays open if the program selector is not set to Night Lock.

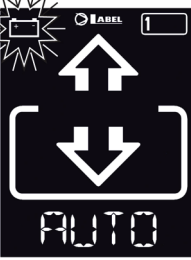
POWER LIGHT DISPLAY		
ON SELECTOR ET-DSEL	ON SELECTOR T-NFC	
		Mains power supply on and battery under charge.
		Mains power supply off and door operating with charged battery.
		<ul style="list-style-type: none"> • Mains power supply off and door operating with battery low. • Mains power supply on with inefficient battery.

6) NOTIFICATION OF ERRORS AND OPERATIONAL ISSUES

PROBLEM	LIKELY CAUSE	SOLUTION
The door opens but it doesn't close back.	The motion radars or the closing safety sensor detect the presence of an object or of a person.	Check that the radars or the sensors are not engaged.
The door doesn't complete the opening cycle and stops along the way.	The opening safety sensor detects an obstacle.	Identify the obstacle and remove it.
The door doesn't respond to the opening commands.	The MANUAL FREE DOOR function can be activated.	Check the setting of the program selector.
The door stops during its motion and inverts the running direction.	The door detects an obstacle along its motion.	Identify the obstacle and remove it.
	The door experiences friction along its motion.	Adjust the door; for this operation please contact the service centre.
The electronic control unit beeps multiple times and door operation is irregular.	The defect depends on the number and length of the beeps.	Contact the service centre to solve the issue.
On the display appears the symbol 	The system has detected a machine operation error.	Contact the service centre to solve the issue.

Should any malfunction occur, the Customer must contact the Support Centre and use the door manually, without powering it.

7) MAINTENANCE

The maintenance plan must be observed to ensure the service life and the safe operation of the automatic door. It is recommended to sign a maintenance contract providing for periodic intervention on the system by specialised technicians.

If the user has the program digital selector ET-DSEL or T-NFC, he will be warned about the expiry of the maintenance interval when the message "SCHEDULED MAINTENANCE" is displayed.

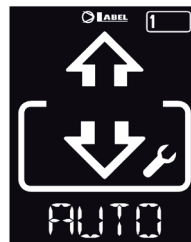
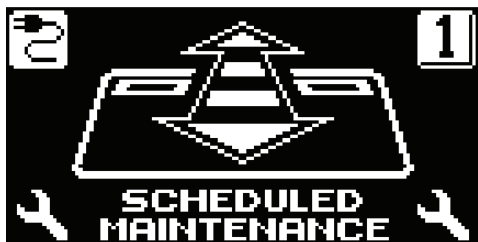

Each maintenance operation is recorded into the maintenance log.

The final user must limit himself to cleaning the glass surfaces, the fixture profiles and if necessary the motion and presence sensors, taking care to lock the door while performing these operations.

8) DISPOSAL

At the end of its lifecycle, this system must be disposed of in accordance with national provisions.

To this purpose, it is recommended to contact specialised operators.



WARNING!

While uninstalling the automations with incorporated spring lock the spring using the special screw before removing the arm;

The spring pre-tensioning may result in an danger!

LABEL service centre



NEPTIS PLUS

Made in Italy
by



Via Ilariuzzi, 17/A - S. Pancrazio P.se - 43126 PARMA - ITALIA
Tel. (+39) 05 21/ 67 52 - Fax (+39) 05 21/ 67 52 22
infocom@labelspa.it - www.labelspa.com

