

LABEL PROFILI E SERRAMENTI PROFILES AND COMPLETE DOORS



Qualità, praticità ed eleganza
Quality, ease of use, and elegance



LABEL

PROFILI E SERRAMENTI

PROFILES AND COMPLETE DOORS

 I **PROFILI IN ALLUMINIO LABEL** sono progettati per durare nel tempo e realizzati con un materiale a basso impatto ambientale. Tutti i Sistemi di Serramenti sono conformi ai più severi criteri di sicurezza antinfortunistica. Se richiesto, l'ingresso Label può essere integrato da un dispositivo omologato per le vie di fuga. Tutti i Sistemi di Serramento sono conformi alle Normative EN 16005 e DM 2006/42 CE.

Le **FINITURE** possono essere **STANDARD O A RICHIESTA** per soddisfare qualsiasi richiesta del cliente o specifica del capitolato.

MODALITÀ DI FORNITURA

Componenti da catalogo

- › LBFL - Sistema di profili per ante a tuttovetro senza intelaiatura
- › LBFL plus - Sistema di profili per ante senza intelaiatura per grandi superfici vetrate
- › LB18, LB35, LB50 - Sistemi di profili per porte scorrevoli
- › Dispositivo antipanico a sfondamento

Ingressi finiti

- › LB18, LB35, LB46, LB50 - Porte scorrevoli
- › LB50 - Porte scorrevoli per vie di fuga

Gli ingressi finiti Label sono disponibili nelle versioni:

smacchinato - fornito in KIT di assemblaggio, già tagliato e lavorato a misura secondo le specifiche fornite al momento dell'ordine. Il kit include i profili, le guarnizioni e gli accessori necessari per le fasi di assemblaggio, vetrazione e posa;

assemblato - completo di profili, guarnizioni ed accessori necessari per le fasi di vetrazione e posa.

Entrambe le soluzioni possono essere fornite con finitura anodizzata argento, verniciata RAL oppure grezza.

 **LABEL ALUMINIUM PROFILES** are designed to last and made from a low environmental impact material. All door systems comply with the most severe safety criteria. If required, the Label entrance can be supplemented by an escape route approved device. All door systems comply with the standards EN 16005 and DM 2006/42 CE.

The **FINISHES** can be **STANDARD OR CUSTOMIZED** to satisfy any customer request or specification.

SUPPLY CONDITIONS

Components included in the catalogue

- › LBFL - Profile systems for frameless glazed leaves
- › LBFL plus - Profile systems for frameless leaves for large glazed surfaces
- › LB18, LB35, LB50 - Profile systems for sliding doors
- › Breakout system

Finished entrances

- › LB18, LB35, LB46, LB50 - Sliding doors
- › LB50 - Sliding doors for escape routes

Label finished entrances are available in the following versions: cut and machined supplied in assembly KIT, cut and machined to size according to the specifications given at the time of the order. The kit includes profiles, seals, and accessories necessary for assembly, glazing and installation;
assembled - complete with profiles, gaskets, and accessories necessary for glazing and installation.

Both solutions can be supplied in silver anodized, RAL painted, or mill finish.

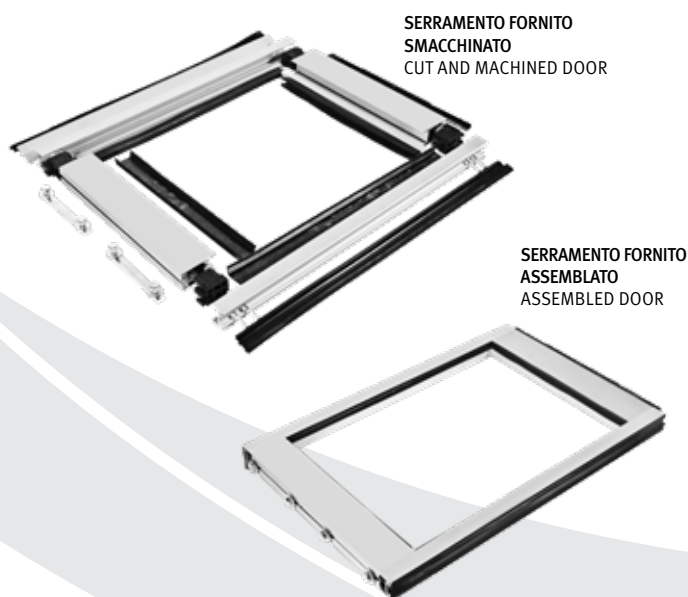

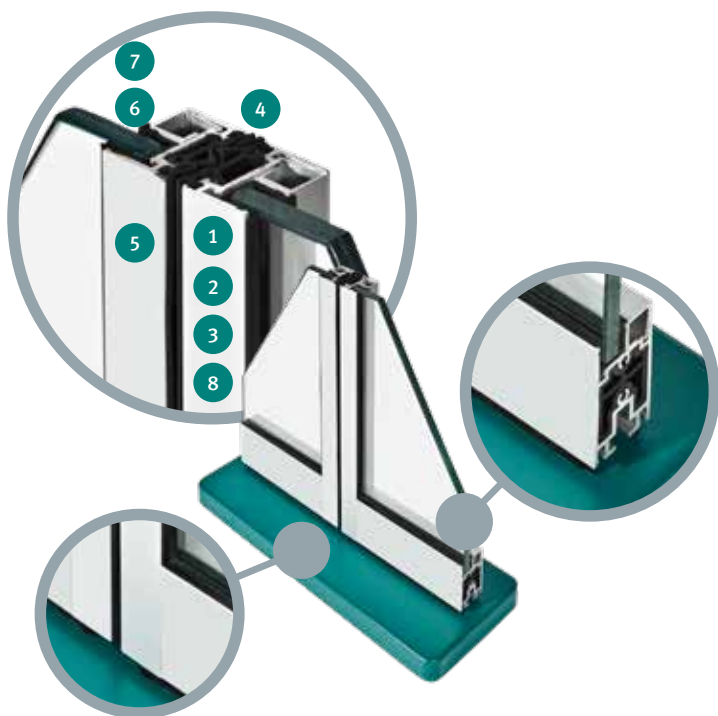

1. Profili estrusi in lega di alluminio EN AW-6060 in accordo con la Norma UNI EN 573.

Extruded profiles in EN AW-6060 aluminium alloy in compliance with the Standard UNI EN 573.

2. Stato di finitura T5 o T6 secondo la Norma UNI EN 515.

T5 or T6 finish according to the Standard UNI EN 515.

3. Tolleranze dimensionali e spessori secondo la Norma UNI EN 12020.2 e/o UNI EN 755-9.

Dimensional tolerances and thicknesses according to the standard UNI EN 12020.2 and/or UNI EN 755-9.

4. Sistema complanare con ante fisse e apribili.

Co-planar system with fixed and opening leaves.

5. Profilo standard sottile, opzionale con camera maggiorata idonea per l'inserimento della serratura.

Slim standard profile; optional with oversize spacer suitable to install the lock.

6. Guarnizioni estraprese a disegno, realizzate in EPDM.

Extruded gaskets according to specifications in EPDM.

7. Sistema predisposto per accogliere vetrazioni tipo:

- Vetro Stratificato di sicurezza EN ISO 12543.
- Vetro Monolitico Temprato EN 12150.
- Vetrate Isolante EN 1279.
- Pannellatura avente le medesime dimensioni dei vetri; finiture commerciali.

System ready to accommodate the following type of glazing:

- Laminated safety glass EN ISO 12543.
- Thermally toughened safety glass EN 12150.
- Insulating glass units EN 1279.
- Panels with the same size as the glazings; commercial finishes.

8. Trattamenti di protezione superficiale:

- Ossidazione anodica conforme alle direttive tecniche europee EURAS-EWAA.
- Verniciatura a polvere termoindurente conforme alle direttive tecniche europee QUALICOAT.

Surface protective treatments:

- Anodizing in compliance with EURAS-EWAA European technical directives.
- Thermoset powder coating applied in compliance with QUALICOAT European technical directives.



TIPOLOGIE DI APERTURE DEL SERRAMENTO TYPES OF DOOR OPENINGS	Anta singola Single slide	Anta singola con laterale fisso Single slide with side screen	Anta doppia Bi-part opening	Anta doppia con laterali fissi Bi-part opening with side screens
VERSIONE SCORREVOLE SLIDING VERSION				
VERSIONE TELESCOPICA TELESCOPIC VERSION				
	2-Moduli/2-Panel	3-Moduli/3-Panel	4-Moduli/4-Panel	6-Moduli/6-Panel

PROFILI E SERRAMENTI PROFILES AND COMPLETE DOORS



AZIENDA CERTIFICATA
SISTEMA QUALITÀ
UNI EN 9001:2015



	LBFL	LBFL Plus	LB18	LB35	LB46	LB50	LB50 Antipanico Breakout
Apertura Scorrevole Sliding opening	✓	✓	✓	✓	✓	✓	✓
Apertura Telescopica Telescopic opening	✓	-	✓	✓	✓	✓	✓
Per vie di fuga* For escape routes*	-	-	-	-	-	-	✓
Numero di ante realizzabili Possible number of leaves	1 / 2 / 4	1	1 / 2 / 4	1 / 2 / 4	1 / 2 / 4	1 / 2 / 4	1 / 2 / 4
Consigliato per uso esterno Recommended for outdoor use	-	-	-	✓	✓	✓	✓
Vetrata isolante Insulating glass	-	-	-	✓	✓	✓	✓
Profili a interruzione termica Thermal break profiles	-	-	-	-	✓	-	-
Serratura meccanica Mechanical lock	-	-	-	opzionale optional	opzionale optional	opzionale optional	opzionale optional
Guida incassata a pavimento Recessed floor guide	-	-	opzionale optional	opzionale optional	opzionale optional	opzionale optional	-
Dimensioni anta realizzabile** L x H (mm) Possible size of leaf** W x H (mm)	1200 x 2500	2000 x 3000	1200 x 2500	1500 x 2500	1500 x 2500	2000 x 3000	1275 x 2300















*Sistema antipanico a sfondamento meccanico.
Tutti i Sistemi di Serramenti Label, se abbinati ad Automazioni Revolus 90, Revolus 150 e Revolus T sono certificati per l'impiego sulle vie di fuga.

**Dimensione indicativa dipendente dalla tipologia di porta e dall'Automazione a essa abbinata.

Mechanical breakout system.
All Label door systems, when combined with automations Revolus 90, Revolus 150, and Revolus T, are certified for use on escape routes.

**Indicative dimension depending on the type of door and the automation associated with it.

TRATTAMENTI E FINITURE SUPERFICIALI* SURFACE TREATMENTS AND FINISHES*

Anodizzato Anodized												
Verniciato per sublimazione Sublimation coated												
Verniciato a polvere Powder coated												

1. Argento/Silver - 2. Elox 2007 - 3. Elox 2008 - 4. Bianco perla/Pearl white - 5. Blu genziana/Gentian blue - 6. Verde muschio/Moss green - 7. Grigio argento/Silver grey - 8. Grigio antracite/Anthracite grey - 9. Grigio chiaro/Light grey - 10. Marrone cioccolata/Chocolate brown - 11. Bianco crema/Cream - 12. Bianco segnale/Signal white - 13. Nero intenso/Jet black - 14. Bianco puro/Clean room white

*Finiture principali, per maggiori chiarimenti contattare il Servizio Commerciale

*Main finishes, for further clarification please contact the Sales Department